

GRUPO  
SEYS  
MUEBLES

*La mejor sobremesa*



Comedores  
*Con esencia*  
Dining room

**TARIFA DE PRECIOS**  
Dining room PRICE LIST

GRUPO  
SEYS  
MUEBLES

Muebles GRUPO SEYS, S.A.

Ctra. Córdoba-Málaga, km. 76  
14900 - LUCENA (Córdoba)  
Tel. 957 50 26 97 - Fax 957 51 34 34  
nacional@gruposseys.com  
www.gruposseys.com

www.sobremesas - 2018





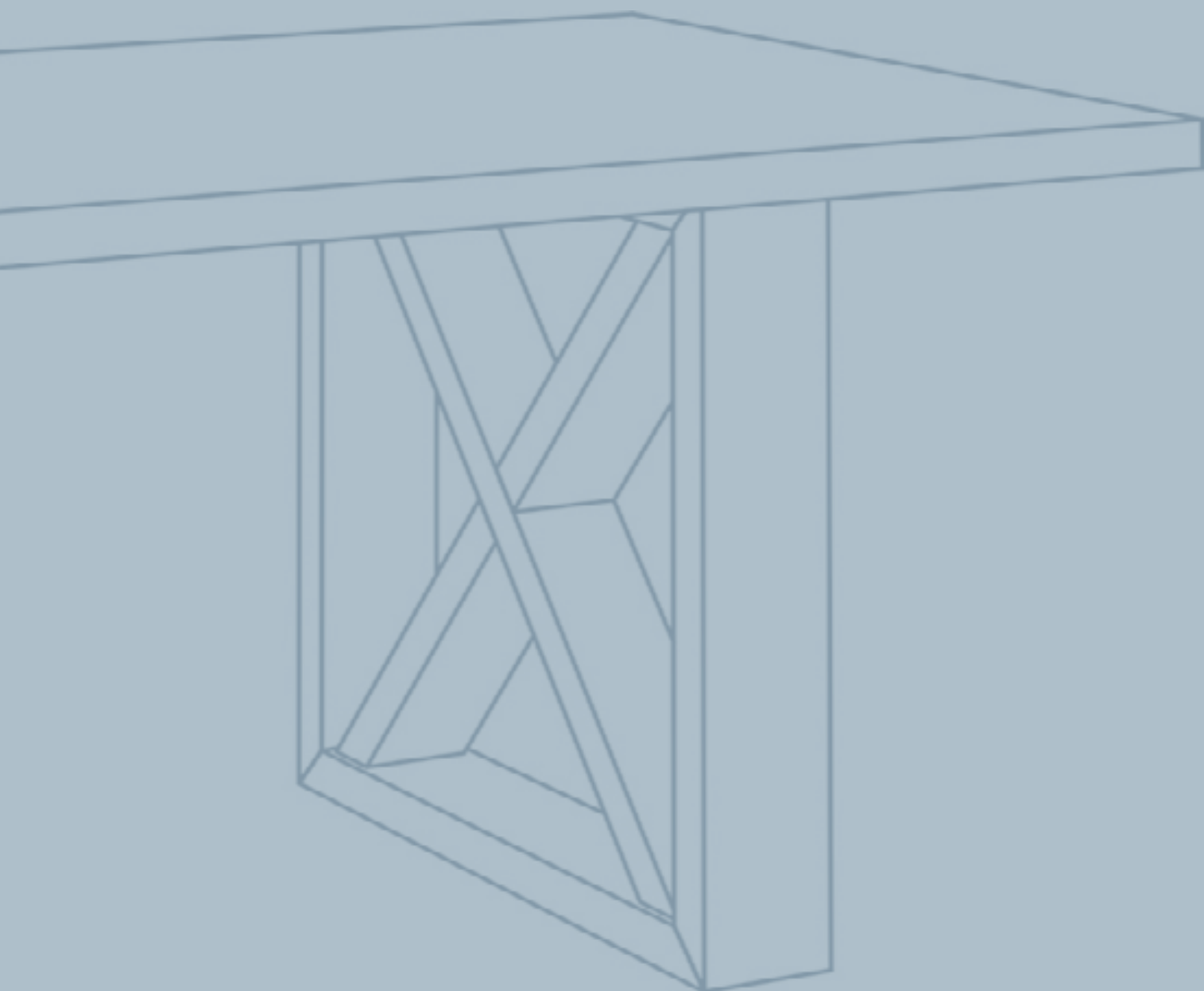

# Auxiliares

## Occasionals

COMEDORES  
DINNING ROOM



**Sillas**  
Chairs

	Ref.	Descripción Description	Medidas cm Measure cm
	<b>SI001</b>	Sillón Colette Colette armchair	61 x 99 x 60  0,440 1 u
	<b>SI002</b>	Sillón Diana Diana armchair	61 x 99 x 60  0,440 1 u
	<b>BB005</b>	Butaca Colette Colette armchair	61 x 95 x 60  0,440 1 u
	<b>BB006</b>	Butaca Diana Diana armchair	61 x 95 x 60  0,440 1 u
	<b>SI003</b>	Silla Frida Frida chair	48 x 96 x 53  0,250 1 u
	<b>SI004</b>	Silla Corina Corina chair	50 x 103 x 58  0,305 1 u
	<b>SI005</b>	Silla Cruceta Cruceta chair	46 x 97 x 54  0,240 1 u

**Tapizados**  
Upholstery

T/cliente	A			B			C			A la arena		
	2	3		2	3		2	3		2	3	
<b>87</b>	<b>95</b>	<b>104</b>		<b>87</b>	<b>95</b>	<b>104</b>	<b>87</b>	<b>95</b>	<b>104</b>	<b>87</b>	<b>95</b>	<b>104</b>
<b>87</b>	<b>95</b>	<b>104</b>		<b>87</b>	<b>95</b>	<b>104</b>	<b>87</b>	<b>95</b>	<b>104</b>	<b>87</b>	<b>95</b>	<b>104</b>
<b>87</b>	<b>95</b>	<b>104</b>		<b>87</b>	<b>95</b>	<b>104</b>	<b>87</b>	<b>95</b>	<b>104</b>	<b>87</b>	<b>95</b>	<b>104</b>
<b>87</b>	<b>95</b>	<b>104</b>		<b>87</b>	<b>95</b>	<b>104</b>	<b>87</b>	<b>95</b>	<b>104</b>	<b>87</b>	<b>95</b>	<b>104</b>
<b>62</b>	<b>66</b>	<b>69</b>		<b>68</b>	<b>72</b>	<b>76</b>	<b>73</b>	<b>78</b>	<b>82</b>	<b>79</b>	<b>83</b>	<b>88</b>
<b>58</b>	<b>63</b>	<b>67</b>		<b>58</b>	<b>63</b>	<b>67</b>	<b>58</b>	<b>63</b>	<b>67</b>	<b>58</b>	<b>63</b>	<b>67</b>
<b>52</b>	<b>54</b>	<b>57</b>		<b>57</b>	<b>60</b>	<b>62</b>	<b>62</b>	<b>65</b>	<b>67</b>	<b>66</b>	<b>69</b>	<b>72</b>

**Sillas**  
Chairs

	Ref.	Descripción Description	Medidas cm Measure cm
	<b>SI006</b>	Silla Landa Landa chair	48 x 94 x 55  0,248 1 u
	<b>SI007</b>	Silla Fontana Fontana chair	46 x 96 x 53  0,234 1 u
	<b>SI008</b>	Silla Aire Aire chair	46 x 100 x 53  0,243 1 u
	<b>SI009</b>	Silla Gales Gales chair	47 x 104 x 53  0,259 1 u
	<b>SI010</b>	Silla Verona Verona chair	46 x 90 x 49  0,202 1 u
	<b>SI011</b>	Silla Segre Segre chair	46 x 88 x 52  0,210 1 u
	<b>SI012</b>	Silla Luxor Luxor chair	47 x 94 x 56  0,247 1 u

**Tapizados**  
Upholstery

		Puntos / Points											
		A			B			C			A la arena		
T/cliente		2	3	T/cliente	2	3	T/cliente	2	3	T/cliente	2	3	
<b>46</b>		<b>48</b>	<b>51</b>	<b>51</b>	<b>53</b>	<b>56</b>	<b>55</b>	<b>57</b>	<b>60</b>	<b>59</b>	<b>61</b>	<b>64</b>	
<b>52</b>		<b>54</b>	<b>57</b>	<b>57</b>	<b>60</b>	<b>62</b>	<b>62</b>	<b>65</b>	<b>67</b>	<b>66</b>	<b>69</b>	<b>72</b>	
<b>68</b>		<b>70</b>	<b>72</b>	<b>75</b>	<b>77</b>	<b>79</b>	<b>81</b>	<b>83</b>	<b>86</b>	<b>87</b>	<b>89</b>	<b>92</b>	
<b>52</b>		<b>54</b>	<b>57</b>	<b>57</b>	<b>60</b>	<b>62</b>	<b>62</b>	<b>65</b>	<b>67</b>	<b>66</b>	<b>69</b>	<b>72</b>	
<b>37</b>		<b>39</b>	<b>41</b>	<b>41</b>	<b>43</b>	<b>45</b>	<b>44</b>	<b>46</b>	<b>49</b>	<b>47</b>	<b>50</b>	<b>52</b>	
<b>44</b>		<b>47</b>	<b>49</b>	<b>49</b>	<b>51</b>	<b>54</b>	<b>52</b>	<b>55</b>	<b>58</b>	<b>56</b>	<b>59</b>	<b>62</b>	
<b>56</b>		<b>60</b>	<b>64</b>	<b>62</b>	<b>66</b>	<b>71</b>	<b>67</b>	<b>71</b>	<b>76</b>	<b>72</b>	<b>76</b>	<b>82</b>	

Todas las sillas se pueden hacer con asiento de madera  
All chairs can be made with wooden seats

**Sillas**  
*Chairs*

**Telas disponibles para grupo 2**  
*Fabrics available for Group 2*



<b>Besora</b>	<b>Lido</b>
<b>Blanes</b>	<b>Mirasol</b>
<b>Bombone</b>	<b>Olot</b>
<b>Brando</b>	<b>Torrent</b>
<b>Brunei</b>	<b>Tortosa</b>
<b>Fonteta</b>	<b>Vinaros</b>
<b>Habana</b>	

**Telas disponibles para grupo 3**  
*Fabrics available for Group 3*



<b>Arturo</b>	<b>Lancelot</b>	<b>Rayong</b>
<b>Bangkok</b>	<b>London</b>	<b>Samvi</b>
<b>Bari</b>	<b>Mitchel</b>	<b>Savona</b>
<b>Como</b>	<b>Moscu</b>	<b>Sofía</b>
<b>Crakovia</b>	<b>Oslo</b>	<b>Viena</b>
<b>Dortmund</b>	<b>Pianord</b>	<b>Voluta</b>
<b>Glasgow</b>	<b>Pisa</b>	
<b>Kiev</b>	<b>Praga</b>	



<b>Libro Adra</b>	<b>Libro Lugano</b>
<b>Libro Aitana</b>	<b>Libro Marina</b>
<b>Libro Aneto</b>	<b>Libro Merida</b>
<b>Libro Carabu-HP</b>	<b>Libro Novara</b>
<b>Libro Eden</b>	<b>Libro Solara</b>
<b>Libro Evora</b>	<b>Libro Vera</b>
<b>Libro Himalaya</b>	









<b>Libro Bellagio</b>	<b>Libro Mika</b>	<b>Libro Romantic</b>
<b>Libro Capriccio</b>	<b>Libro Minerva</b>	<b>Libro Samira</b>
<b>Libro Fantasy</b>	<b>Libro Moon</b>	<b>Libro Vivalto</b>
<b>Libro Harika</b>	<b>Libro Mystic</b>	
<b>Libro Invictus</b>	<b>Libro Nanao</b>	
<b>Libro Keops</b>	<b>Libro Naomi</b>	
<b>Libro Matsue</b>	<b>Libro Otaru</b>	

Ref.	Descripción <i>Description</i>	Metraje m <i>Measure cm</i>
SI001	Sillón Colette / <i>Colette armchair</i>	2,5
SI002	Sillón Diana / <i>Diana armchair</i>	2,5
SI003	Silla Frida / <i>Frida chair</i>	1,1
SI004	Silla Corina / <i>Corina chair</i>	1,3
SI005	Silla Cruceta / <i>Cruceta chair</i>	0,6
SI006	Silla Landa / <i>Landa chair</i>	0,6
SI007	Silla Fontana / <i>Fontana chair</i>	0,6
SI008	Silla Aire / <i>Aire chair</i>	0,6
SI009	Silla Gales / <i>Gales chair</i>	0,6
SI010	Silla Verona / <i>Verona chair</i>	0,6
SI011	Silla Segre / <i>Segre chair</i>	0,6
SI012	Silla Luxor / <i>Luxor chair</i>	1
BB001	Banqueta con cajón Basilea / <i>Bench with drawer Basilea</i>	0,7
BB002	Banqueta Basilea / <i>Bench Basilea</i>	0,7
BB003	Banqueta Fontana / <i>Bench Fontana</i>	0,7
BB004	Banqueta Mediterráneo / <i>Bench Mediterraneo</i>	0,7
BB005	Butaca Colette / <i>Headboard Colette</i>	2,5
BB006	Butaca Diana / <i>Headboard Diana</i>	2,5

\* Esta lista está sujeta a posibles actualizaciones, consultar página web [www.gruposeys.com](http://www.gruposeys.com) / Para pedidos de grupo "Tela cliente consultar metraje necesario.

*This list is subject to possible updates, consult website [www.gruposeys.com](http://www.gruposeys.com) / For group orders "Cloth client consult necessary footage*

**Mesas fijas**  
*Fixed table*

Ref.	Descripción <i>Description</i>	Medidas cm <i>Measure cm</i>	Puntos <i>Points</i>			
			A	B	C	A la Arena
 <b>ME001</b>	Mesa Santa Clara de 160 <i>Santa Clara Table of 160</i>	160 x 76 x 90  m <sup>2</sup> 0,525  3 u	194	213	230	247
 <b>ME002</b>	Mesa Santa Clara de 180 <i>Santa Clara Table of 180</i>	180 x 76 x 90  m <sup>2</sup> 0,530  3 u	207	228	246	263
 <b>ME003</b>	Mesa Santa Clara de 200 <i>Santa Clara Table of 200</i>	200 x 76 x 100  m <sup>2</sup> 0,544  3 u	227	249	269	288
 <b>ME004</b>	Mesa Arosa de 160 <i>Arosa Table of 160</i>	160 x 76 x 90  m <sup>2</sup> 0,246  3 u	194	213	230	247
 <b>ME005</b>	Mesa Arosa de 180 <i>Arosa Table of 180</i>	180 x 76 x 90  m <sup>2</sup> 0,250  3 u	207	228	246	263
 <b>ME006</b>	Mesa Arosa de 200 <i>Arosa Table of 200</i>	200 x 76 x 100  m <sup>2</sup> 0,265  3 u	227	249	269	288
 <b>ME007</b>	Mesa Alborán de 160 <i>Alboran Table of 160</i>	160 x 76 x 90  m <sup>2</sup> 0,215  3 u	198	217	235	251

**Mesas fijas**  
*Fixed table*

Ref.	Descripción <i>Description</i>	Medidas cm <i>Measure cm</i>	Puntos <i>Points</i>			
			A	B	C	A la Arena
 <b>ME008</b>	Mesa Alborán de 180 <i>Alboran Table of 180</i>	180 x 76 x 90  m <sup>2</sup> 0,220  3 u	211	232	250	268
 <b>ME009</b>	Mesa Alborán de 200 <i>Alboran Table of 200</i>	200 x 76 x 100  m <sup>2</sup> 0,234  3 u	231	254	274	293
 <b>ME010</b>	Mesa redonda Santa Clara Ø 120 <i>Round table Santa Clara Ø 120</i>	Ø 120 x 76  m <sup>2</sup> 0,539  3 u	221	244	263	281
 <b>ME011</b>	Mesa centro Tabarca <i>Tabarca center table</i>	120 x 46,5 x 70  m <sup>2</sup> 0,733  2 u	159	175	189	202
 <b>ME012</b>	Mesa centro Santa Clara <i>Santa Clara center table</i>	120 x 46,5 x 70  m <sup>2</sup> 0,733  2 u	165	181	196	209
 <b>ME026</b>	Mesa centro elevable pata agujada <i>Lift-up coffee table, pointed legs</i>	100 x 47 x 55  m <sup>2</sup> 0,263  1 u	72	80	85	91

\* Las tapas de 4,5cm de grosor, se pueden fabricar en madera maciza o chapa natural. Especificar en el pedido.

\* The covers of 4.5cm in thickness, can be manufactured in solid wood or natural veneer. Specify in the order.

**MESAS de 140 fija con forma en tabica**  
Table 140 pull-out with saph

Ref.	Descripción Description	Medidas cm Measure cm	Puntos Points			
			A	B	C	A la Arena
 <b>ME013</b>	Mesa rectangular fija de 140 c/ forma en tabica con pata Fontana <i>Fixed rectangular table 140 w/ Fontana legs</i>	140 x 75 x 90	<b>121</b>	<b>134</b>	<b>144</b>	<b>154</b>
		 0,260  1 u				
 <b>ME014</b>	Mesa rectangular fija de 140 c/ forma en tabica con pata Mediterráneo <i>Fixed rectangular table 140 w/ Mediterraneo legs</i>	140 x 75 x 90	<b>145</b>	<b>161</b>	<b>173</b>	<b>185</b>
		 0,260  1 u				



**MESAS de 140 fija recta**  
Fixed table 140 straight

Ref.	Descripción Description	Medidas cm Measure cm	Puntos Points			
			A	B	C	A la Arena
 <b>ME015</b>	Mesa rectangular fija de 140 recta con pata Fontana <i>Fixed rectangular table 140 straight w/ Fontana legs</i>	140 x 75 x 90	<b>112</b>	<b>125</b>	<b>133</b>	<b>142</b>
		 0,260  1 u				
 <b>ME016</b>	Mesa rectangular fija de 140 recta con pata Mediterráneo <i>Fixed rectangular table 140 straight w/ Mediterraneo legs</i>	140 x 75 x 90	<b>137</b>	<b>152</b>	<b>162</b>	<b>173</b>
		 0,260  1 u				

**MESAS de 140 desplazable con forma en tabica (se amplía solo tapa)**













Ref.	Descripción Description	Medidas cm Measure cm	Puntos Points			
			A	B	C	A la Arena
 <b>ME017</b>	Mesa rectangular de 140 desplazable c/forma en tabica con pata Fontana (extendida 200 x 75 x 90) se amplía solo tapa <i>Rectangular table 140 moveable w/ Fontana legs (extends to 200 x 75 x 90)</i>	140 x 75 x 90	<b>155</b>	<b>172</b>	<b>184</b>	<b>197</b>
		 0,260  1 u				
 <b>ME018</b>	Mesa rectangular de 140 desplazable c/forma en tabica con pata Mediterráneo (Extendida 200 x 75 x 90) se amplía solo tapa <i>Rectangular table 140 moveable w/ Mediterraneo legs (extends to 200 x 75 x 90)</i>	140 x 75 x 90	<b>178</b>	<b>198</b>	<b>212</b>	<b>227</b>
		 0,260  1 u				

**MESAS de 140 desplazable recta (se amplía solo tapa)**

Ref.	Descripción Description	Medidas cm Measure cm	Puntos Points			
			A	B	C	A la Arena
 <b>ME019</b>	Mesa rectangular de 140 desplazable recta con pata Fontana (extendida 200 x 75 x 90) se amplía solo tapa <i>Rectangular table 140 moveable straight w/ Fontana legs (extends to 200 x 75 x 90)</i>	140 x 75 x 90	<b>144</b>	<b>160</b>	<b>171</b>	<b>183</b>
		 0,260  1 u				
 <b>ME020</b>	Mesa rectangular de 140 desplazable recta con pata Mediterráneo (extendida 200 x 75 x 90) se amplía solo tapa <i>Rectangular table 140 moveable straight w/ Mediterraneo legs (extends to 200 x 75 x 90)</i>	140 x 75 x 90	<b>169</b>	<b>187</b>	<b>200</b>	<b>214</b>
		 0,260  1 u				



### MESAS de 140 estirable recta (se amplía tapa y pata)

Pull-out table  
140 straight  
(top & legs extend)

Ref.	Descripción Description	Medidas cm Measure cm	Puntos Points			
			A	B	C	A la Arena
 <b>ME021</b>	Mesa rectangular de 140 estirable recta con pata Fontana (extendida 200 x 75 x 90) se amplía tapa y pata <i>Rectangular table 140 pull-out straight w/ Fontana legs (extends to 200 x 75 x 90)</i>	140 x 75 x 90	<b>204</b>	<b>226</b>	<b>242</b>	<b>259</b>
		 0,260  1 u				
 <b>ME022</b>	Mesa rectangular de 140 estirable recta con pata Mediterráneo (extendida 200 x 75 x 90) se amplía tapa y pata <i>Rectangular table 140 pull-out straight w/ Mediterraneo legs (extends to 200 x 75 x 90)</i>	140 x 75 x 90	<b>228</b>	<b>253</b>	<b>271</b>	<b>290</b>
		 0,260  1 u				
 <b>ME023</b>	Mesa de 140 estirable Madeira (extendida 200 x 77 x 90) se amplía tapa y pata <i>Table 140 pull-out straight w/ Fontana legs (extends to 200 x 77 x 90)</i>	140 x 77 x 90	<b>178</b>	<b>198</b>	<b>212</b>	<b>227</b>
		 0,260  1 u				
 <b>ME025</b>	Mesa de 140 estirable pata agujada (extendida 200 x 77 x 90) se amplía tapa y pata <i>Table 140 pull-out straight w/ tapered legs (extends to 200 x 77 x 90)</i>	140x 77 x 90	<b>178</b>	<b>198</b>	<b>212</b>	<b>227</b>
		 0,260  1 u				

### MESAS de 160 desplazable con forma en tabica (se amplía solo tapa)

Table 160 pull-out with  
shape (top extends only)

Ref.	Descripción Description	Medidas cm Measure cm	Puntos Points			
			A	B	C	A la Arena
 <b>ME027</b>	Mesa rectangular de 160 desplazable c/ forma en tabica con pata Fontana (extendida 220 x 75 x 90) se amplía solo tapa <i>Rectangular table 160 moveable w/ Fontana legs (extends to 200 x 75 x 90)</i>	160 x 75 x 90	<b>172</b>	<b>191</b>	<b>204</b>	<b>218</b>
		 0,260  1 u				
 <b>ME028</b>	Mesa rectangular de 160 desplazable c/ forma en tabica con pata Mediterráneo (extendida 220 x 75 x 90) se amplía solo tapa <i>Rectangular table 160 moveable w/ Mediterraneo legs (extends to 220 x 75 x 90)</i>	160 x 75 x 90	<b>196</b>	<b>217</b>	<b>233</b>	<b>249</b>
		 0,260  1 u				

### MESAS de 160 desplazable recta (se amplía solo tapa)

Pull-out table  
160 straight  
(top & legs extend)

Ref.	Descripción Description	Medidas cm Measure cm	Puntos Points			
			A	B	C	A la Arena
 <b>ME029</b>	Mesa rectangular de 160 desplazable recta con pata Fontana (extendida 220 x 75 x 90) se amplía solo tapa <i>Rectangular table 160 moveable straight w/ Fontana legs (extends to 220 x 75 x 90)</i>	160 x 75 x 90	<b>163</b>	<b>181</b>	<b>193</b>	<b>207</b>
		 0,260  1 u				
 <b>ME030</b>	Mesa rectangular de 160 desplazable recta con pata Mediterráneo (extendida 220 x 75 x 90) se amplía solo tapa <i>Rectangular table 160 moveable straight w/ Mediterraneo legs (extends to 220 x 75 x 90)</i>	160 x 75 x 90	<b>187</b>	<b>208</b>	<b>222</b>	<b>238</b>
		 0,260  1 u				



























**Estantes  
y complementos**  
*Wall shelf*

Ref.	Descripción <i>Description</i>	Medidas cm <i>Measure cm</i>	Puntos <i>Points</i>			
			A	B	C	A la Arena
 <b>EC001</b>	Estante de pared de 40 <i>Wall shelf 40</i>	40 x 4 x 20  0,004  1 u	14	16	17	18
 <b>EC002</b>	Estante de pared de 80 <i>Wall shelf 80</i>	80 x 4 x 20  0,009  1 u	17	19	20	21
 <b>EC003</b>	Estante de pared de 90 <i>Wall shelf 90</i>	90 x 4 x 20  0,010  1 u	19	21	23	25
 <b>EC004</b>	Estante de pared de 100 <i>Wall shelf 100</i>	100 x 4 x 20  0,011  1 u	20	22	24	26
 <b>EC005</b>	Estante de pared de 120 <i>Wall shelf 120</i>	120 x 4 x 20  0,013  1 u	22	24	26	28
 <b>EC006</b>	Estante de pared de 130 <i>Wall shelf 130</i>	130 x 4 x 20  0,014  1 u	25	28	30	32
 <b>EC007</b>	Estante de pared de 140 <i>Wall shelf 140</i>	140 x 4 x 20  0,015  1 u	27	30	32	34
 <b>EC008</b>	Estante de pared de 150 <i>Wall shelf 150</i>	150 x 4 x 20  0,016  1 u	28	31	33	35
 <b>EC009</b>	Estante de pared de 160 <i>Wall shelf 160</i>	160 x 4 x 20  0,017  1 u	30	33	36	39
 <b>EC010</b>	Estante de pared de 180 <i>Wall shelf 180</i>	180 x 4 x 20  0,019  1 u	33	37	39	42
 <b>EC011</b>	Estante de pared de 210 <i>Wall shelf 210</i>	210 x 4 x 20  0,022  1 u	36	40	43	46
 <b>EC012</b>	Cubo estante (cuadrado) <i>Square cube shelf</i>	40 x 40 x 25  0,043  1 u	21	23	25	27
 <b>EC013</b>	Cubo estante (rectangular) <i>Rectangular cube shelf</i>	70 x 35 x 25  0,070  1 u	32	36	38	41
 <b>EC014</b>	Cubo estante doble <i>Double cube shelf</i>	95 x 55 x 25  0,137  1 u	56	62	66	71

\* Los soportes de estantes están incluidos \* *Note: The shelf supports are included*

**Estantes  
y complementos**  
*Wall shelf*

Ref.	Descripción <i>Description</i>	Medidas cm <i>Measure cm</i>	Puntos <i>Points</i>			
			A	B	C	A la Arena
 <b>EC015</b>	Juego de bucks de piel <i>Set leather bucks</i>	Color: Marrón Color: Beige  0,044  1 u	26	26	26	26
 <b>EC016</b>	Espejo Narcea (metálico) <i>Metallic mirror Narcea</i>	70 x 98 x 6  0,050  1 u	65	65	65	65
 <b>CD010</b>	Espejo tríptico Cerdeña <i>Cerdeña 3-panel mirror</i>	119 X 110 X 3,3  0,050  1 u	74	82	88	95
 <b>VD015</b>	Espejo vestidor Verona <i>Dressing mirror Verona</i>	60 x 143 x 2,5  0,026  1 u	52	57	61	65
 <b>BD015</b>	Espejo de 94 x 86 sin celosía Basilea <i>Basilea mirror 94 x 86, no lattice work</i>	94 x 86 x 6  0,058  1 u	46	51	55	59
 <b>BD017</b>	Espejo de 66 x 63 Basilea <i>Mirror Basilea</i>	66 x 63 x 6  0,027  1 u	55	57	61	65
 <b>FC004</b>	Espejo de 65x 82 Fontana <i>Mirror Fontana</i>	65 x 82 x 3  0,022  1 u	34	38	40	43
 <b>FC002</b>	Percha puerta abatible Fontana <i>Fontana coat stand w/ foldout door</i>	64 x 170 x 20  0,254  1 u	93	103	110	118



























# PROGRAMA LIBRERIAS

## Libraries Program































COMEDORES  
DINNING ROOM



Para altura  
88 cm con puertas  
Height 88 cm with doors

Ref.	Descripción Description	Medidas cm Measure cm	Puntos Points			
			A	B	C	A la Arena
 <b>EL002</b>	Costado izquierdo madera de 88 para puertas <i>Left wood side panel 88 for doors</i>	35 x 84,9 x 3,2  0,015  1 u	14	16	17	18
 <b>EL004</b>	Costado derecho madera de 88 para puertas <i>Right wood side panel 88 for doors</i>	35 x 84,9 x 3,2  0,015  1 u	14	16	17	18
 <b>EL006</b>	Costado central madera de 88 para puertas <i>Central wood side panel 160 for doors</i>	35 x 84,9 x 3,2  0,015  1 u	17	18	20	21
 <b>EL007</b>	Trasera módulo 2 puertas de 88 <i>Back panel for 2-door module 160</i>	95 x 80 x 0,6  0,005  1 u	6	7	8	9
 <b>EL008</b>	Trasera módulo 1 puerta de 88 <i>Back panel for 1-door module 160</i>	48,6 x 80 x 0,6  0,002  1 u	3	4	5	6
 <b>EL042</b>	Techo módulo 1 puerta para altura 88 y 160 <i>Top panel for 1-door module for heights 88 and 160</i>	34,3 x 46,6 x 1,9  0,003  1 u	9	10	11	12
 <b>EL043</b>	Techo módulo 2 puerta para altura 88 y 160 <i>Top panel for 2-door module for heights 88 and 160</i>	34,3 x 93 x 1,9  0,006  1 u	15	17	18	20
 <b>EL048</b>	Estante módulo 1 puerta <i>1-door module shelf</i>	30,3 x 46,6 x 1,9  0,003  1 u	8	9	10	11
 <b>EL049</b>	Estante módulo 2 puerta <i>2-door module shelf</i>	30,3 x 93 x 1,9  0,005  1 u	15	16	18	19

Para altura  
88 cm con puertas  
Height 88 cm with doors

Ref.	Descripción Description	Medidas cm Measure cm	Puntos Points			
			A	B	C	A la Arena
 <b>EL050</b>	Base módulo 1 puerta <i>1-door module base</i>	35 x 46,6 x 5  0,008  1 u	12	13	14	15
 <b>EL051</b>	Base módulo 2 puerta <i>2-door module base</i>	35 x 93 x 5  0,017  1 u	21	23	25	27
 <b>EL054</b>	Puerta baja cristal para altura de 88 y 240 <i>Low glass door for heights 88 and 240</i>	46,2 x 77,6 x 2,5  0,009  1 u	11	12	13	14
 <b>EL055</b>	Puerta baja madera para altura de 88 y 240 <i>Low wood door for heights 88 and 240</i>	46,2 x 77,6 x 2,5  0,009  1 u	18	20	22	23
 <b>EL056</b>	Tapa 1 módulo de 1 puerta para altura 88 y 160 <i>Top panel for 1-door module for heights 88 and 160</i>	56 x 38 x 3  0,007  1 u	11	12	13	14
 <b>EL057</b>	Tapa 1 módulo de 2 puertas para altura 88 y 160 <i>Top panel for 2-door module for heights 88 and 160</i>	105 x 39 x 3  0,013  1 u	19	20	22	24
 <b>EL058</b>	Tapa 1 módulo de 1 puerta y 1 de 2 puertas para altura de 88 y 160 <i>Top panel for 1-door module plus 2-door module for heights 88 and 160</i>	152 x 38 x 3  0,018  1 u	26	29	31	33
 <b>EL059</b>	Tapa 2 módulos de 2 puertas para altura de 88 y 160 <i>Top panel for 2-door double module for heights 88 and 160</i>	198 x 38 x 3  0,023  1 u	33	37	40	43
 <b>EL060</b>	Tapa 1 módulo de 1 puerta y 2 de 2 puertas para altura 88 y 160 <i>Top panel for 1-door module plus 2-door double module for heights 88 and 160</i>	248 x 38 x 3  0,029  1 u	53	58	62	67
 <b>EL061</b>	Tapa 3 módulos de 2 puertas para altura de 88 y 160 <i>Top panel for three 2-door modules for heights 88 and 160</i>	295 x 38 x 3  0,034  1 u	62	68	73	79

Para altura 88 cm con puertas  
Height 88 cm with doors

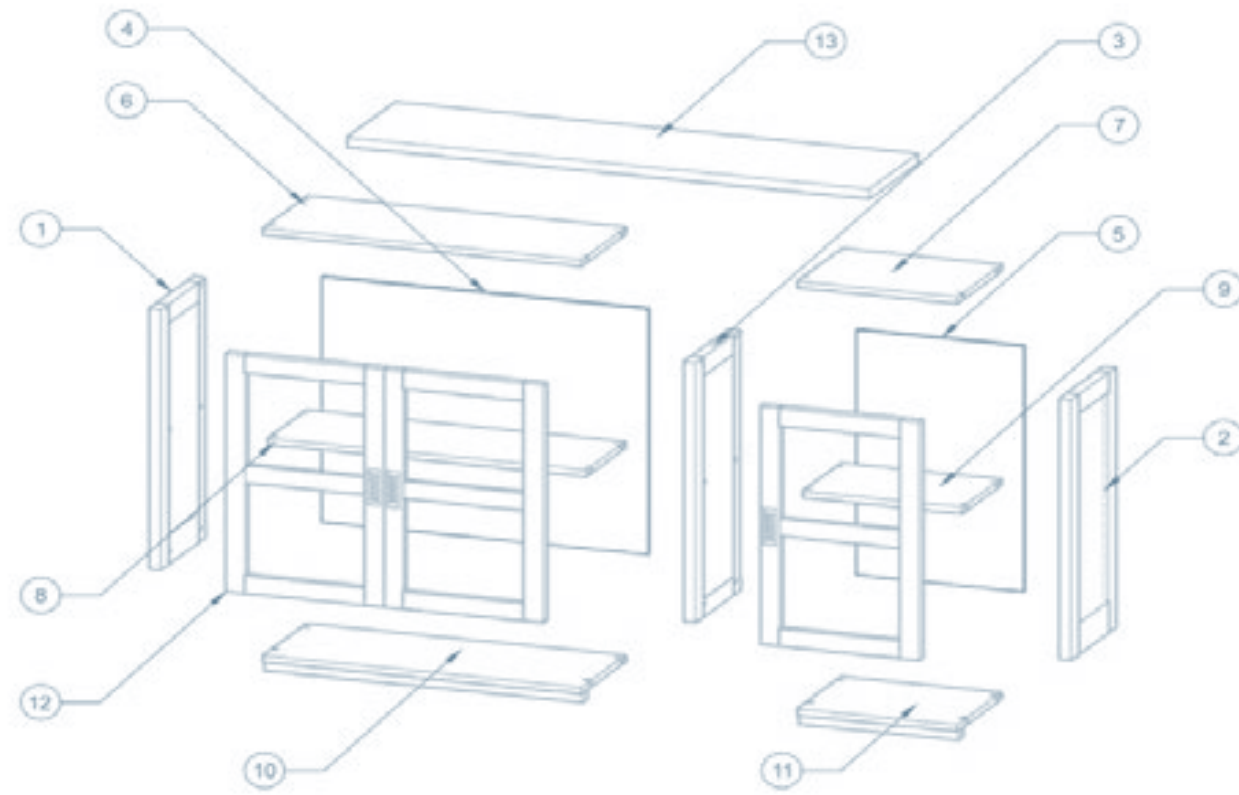





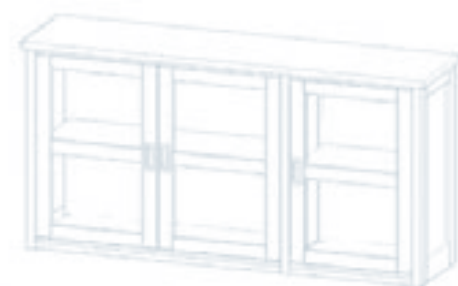















1	EL002	Costado izquierdo madera de 88 para puertas
2	EL004	Costado derecho madera de 88 para puertas
3	EL006	Costado central madera de 88 para puertas
4	EL007	Trasera módulo 2 puertas de 88
5	EL008	Trasera módulo 1 puerta de 88
7	EL042	Techo módulo 1 puerta para altura 88 y 160
6	EL043	Techo módulo 2 puerta para altura 88 y 160

9	EL048	Estante módulo 1 puerta
8	EL049	Estante módulo 2 puerta
11	EL050	Base módulo 1 puerta
10	EL051	Base módulo 2 puerta
12	EL054 EL055	Puerta baja cristal o madera para altura de 88 y 240
13	EL058	Tapa 1 módulo de 1 puerta y 1 de 2 puertas para altura de 88 y 160



































Para altura 160 cm con puertas  
Height 160 cm with doors

			A	B	C	A la Arena	
	<b>EL009</b>	Costado izquierdo cristal de 160 Left glass side panel 160	35 x 157 x 3,2  0,020  1 u	16	17	19	20
	<b>EL010</b>	Costado derecho cristal de 160 Right glass side panel 240	35 x 157 x 3,2  0,020  1 u	16	17	19	20
	<b>EL012</b>	Costado izquierdo madera de 160 para puertas Left wood side panel 160 for doors	35 x 157 x 3,2  0,020  1 u	24	26	28	30
	<b>EL014</b>	Costado derecho madera de 160 para puertas Right wood side panel 160 for doors	35 x 157 x 3,2  0,020  1 u	24	26	28	30
	<b>EL016</b>	Costado central de 160 para puertas Central wood side panel 160 for doors	35 x 157 x 3,2  0,020  1 u	15	17	18	20
	<b>EL017</b>	Trasera módulo 2 puertas de 160 Back panel for 2-door module 160	95 x 152,1 x 0,6  0,009  1 u	12	13	14	15
	<b>EL018</b>	Trasera módulo 1 puerta de 160 Back panel for 1-door module 160	48,6 x 152,1 x 0,6  0,005  1 u	6	7	8	9







Para altura 160 cm con puertas

Height 160 cm with doors

Ref.	Descripción Description	Medidas cm Measure cm	Puntos Points			
			A	B	C	A la Arena
 <b>EL042</b>	Techo módulo 1 puerta para altura 88 y 160 <i>Top panel for 1-door module for heights 88 and 160</i>	34,3 x 46,6 x 1,9  0,003  1 u	9	10	11	12
 <b>EL043</b>	Techo módulo 2 puertas para altura 88 y 160 <i>Top panel for 2-door module for heights 88 and 160</i>	34,3 x 93 x 1,9  0,006  1 u	15	17	18	20
 <b>EL048</b>	Estante módulo 1 puerta <i>1-door module shelf</i>	30,3 x 46,6 x 1,9  0,003  1 u	8	9	10	11
 <b>EL049</b>	Estante módulo 2 puertas <i>2-door module shelf</i>	30,3 x 93 x 1,9  0,005  1 u	15	16	18	19
 <b>EL050</b>	Base módulo 1 puerta <i>1-door module base</i>	35 x 46,6 x 5  0,008  1 u	12	13	14	15
 <b>EL051</b>	Base módulo 2 puertas <i>2-door module base</i>	35 x 93 x 5  0,017  1 u	21	23	25	27
 <b>EL052</b>	Puerta alta cristal para altura de 160 y 240 <i>High glass door for heights 160 and 240</i>	46,2 x 149,7 x 2,5  0,018  1 u	15	17	18	20
 <b>EL056</b>	Tapa 1 módulo de 1 puerta para altura 88 y 160 <i>Top panel for 1-door module for heights 88 and 160</i>	56 x 38 x 3  0,007  1 u	11	12	13	14
 <b>EL057</b>	Tapa 1 módulo de 2 puertas para altura 88 y 160 <i>Top panel for 2-door module for heights 88 and 160</i>	105 x 39 x 3  0,013  1 u	19	20	22	24
 <b>EL058</b>	Tapa 1 módulo de 1 puerta y 1 de 2 puertas para altura de 88 y 160 <i>Top panel for 1-door module plus 2-door module for heights 88 and 160</i>	152 x 38 x 3  0,018  1 u	26	29	31	33
 <b>EL059</b>	Tapa 2 módulos de 2 puertas para altura de 88 y 160 <i>Top panel for 2-door double module for heights 88 and 160</i>	198 x 38 x 3  0,023  1 u	33	37	40	43

Para altura 160 cm con puertas

Height 160 cm with doors

Ref.	Descripción Description	Medidas cm Measure cm	Puntos Points			
			A	B	C	A la Arena
 <b>EL060</b>	Tapa 1 módulo de 1 puerta y 2 de 2 puertas para altura 88 y 160 <i>Top panel for 1-door module plus 2-door double module for heights 88 and 160</i>	248 x 38 x 3  0,029  1 u	53	58	62	67
 <b>EL061</b>	Tapa 3 módulos de 2 puertas para altura de 88 y 160 <i>Top panel for three 2-door modules for heights 88 and 160</i>	295 x 38 x 3  0,034  1 u	62	68	73	79

Altura 160 con puertas  
Height 160 with doors

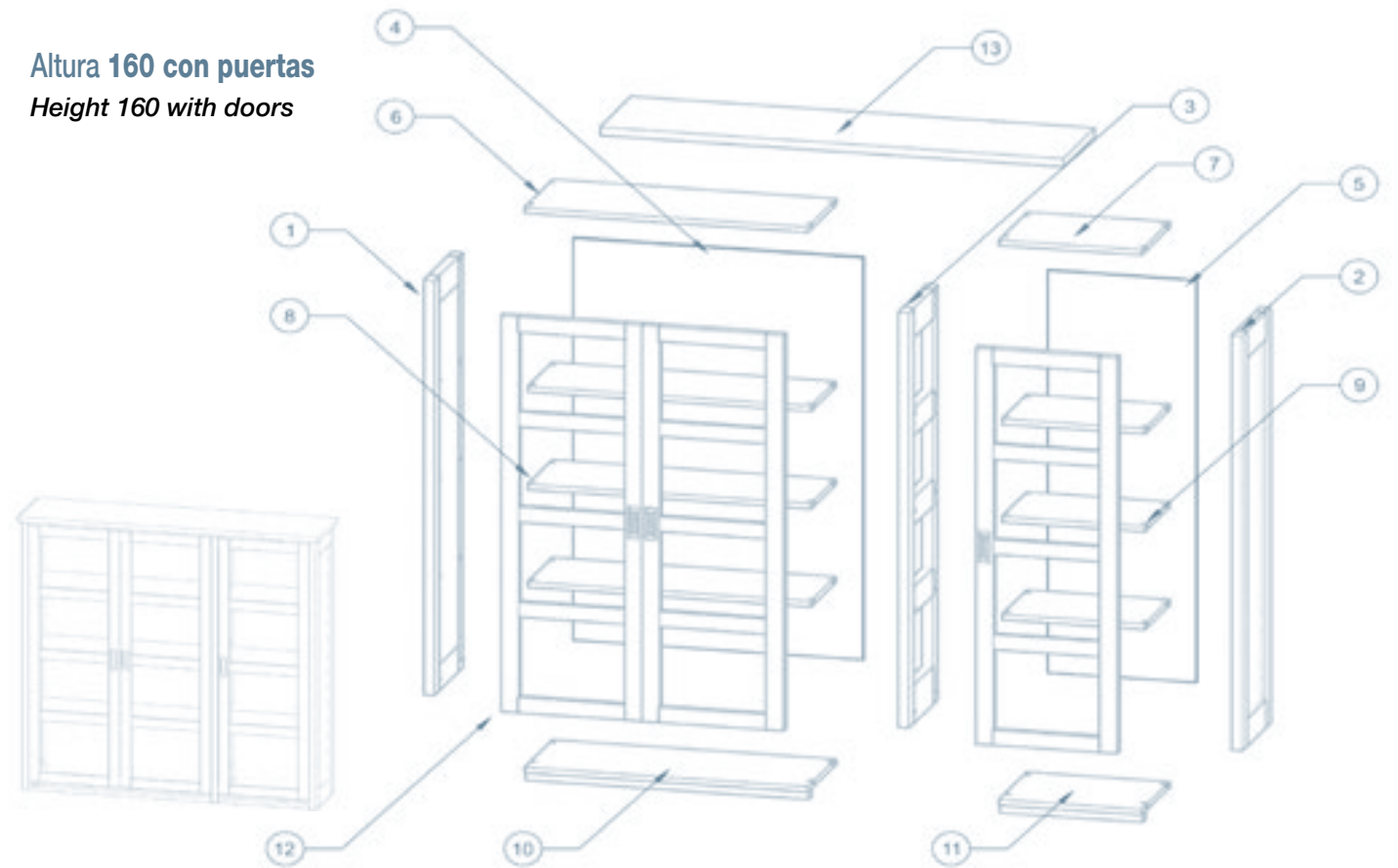











1	EL009 EL012	Costado izquierdo cristal o madera de 160 para puerta
2	EL010 EL014	Costado derecho cristal o madera de 160 para puerta
3	EL016	Costado central de 160 para puertas
4	EL017	Trasera módulo 2 puertas de 160
5	EL018	Trasera módulo 1 puerta altura 160
6	EL043	Techo módulo 2 puertas altura 88 y 160
7	EL042	Techo módulo 1 puerta altura 88 y 160

8	EL049	Estante módulo 2 puertas, x3 en esta composición
9	EL048	Estante módulo 1 puerta, x3 en esta composición
10	EL051	Base módulo 2 puerta
11	EL050	Base módulo 1 puerta
12	EL052	Puerta cristal alta par altura 160 y 240, x3 en esta composición
13	EL058	Tapa para altura 88 y 160, largo según número de módulos























Para altura 200 cm  
con puertas

Height 200 cm with doors

Ref.	Descripción Description	Medidas cm Measure cm	Puntos Points			
			A	B	C	A la Arena
 <b>EL019</b>	Costado izquierdo cristal de 200 <i>Left glass side panel 200</i>	36,5 x 201 x 4,7  0,035  1 u	26	28	30	33
 <b>EL020</b>	Costado derecho cristal de 200 <i>Right glass side panel 200</i>	36,5 x 201 x 4,7  0,035  1 u	26	28	30	33
 <b>EL022</b>	Costado izquierdo madera de 200 para puertas <i>Left wood side panel 200 for doors</i>	36,5 x 201 x 4,7  0,035  1 u	32	35	38	40
 <b>EL024</b>	Costado derecho madera de 200 para puertas <i>Right wood side panel 200 for doors</i>	36,5 x 201 x 4,7  0,35  1 u	32	35	38	40
 <b>EL026</b>	Costado central de 200 para puertas <i>Central wood side panel 200 for doors</i>	36,5 x 201 x 4,7  0,35  1 u	19	21	23	24
 <b>EL027</b>	Trasera módulo 2 puertas de 200 <i>Back panel for 2-door module 200</i>	95 x 192 x 0,6  0,011  1 u	14	16	17	18
 <b>EL028</b>	Trasera módulo 1 puerta de 200 <i>Back panel for 1-door module 200</i>	48,6 x 192 x 0,6  0,006  1 u	7	8	9	10

Para altura 200 cm  
con puertas

Height 200 cm with doors

Ref.	Descripción Description	Medidas cm Measure cm	Puntos Points			
			A	B	C	A la Arena
 <b>EL044</b>	Techo módulo 1 puerta para altura 200 y 240 <i>Top panel for 1-door module for heights 200 and 240</i>	36 x 46 x 5  0,008  1 u	10	11	12	12
 <b>EL045</b>	Techo módulo 2 puerta para altura 200 y 240 <i>Top panel for 2-door module for heights 200 and 240</i>	36 x 93 x 5  0,017  1 u	17	19	20	22
 <b>EL048</b>	Estante módulo 1 puerta <i>1-door module shelf</i>	30,3 x 46,6 x 1,9  0,003  1 u	8	9	10	11
 <b>EL049</b>	Estante módulo 2 puerta <i>2-door module shelf</i>	30,3 x 93 x 1,9  0,005  1 u	15	16	18	19
 <b>EL050</b>	Base módulo 1 puerta <i>1-door module base</i>	35 x 46,6 x 5  0,008  1 u	12	13	14	15
 <b>EL051</b>	Base módulo 2 puerta <i>2-door module base</i>	35 x 93 x 5  0,017  1 u	21	23	25	27
 <b>EL053</b>	Puerta izquierda cristal para altura 200 <i>Left glass door for height 200</i>	46,2 x 190,7 x 2,5  0,027  1 u	27	29	31	34
 <b>EL062</b>	Puerta derecha cristal para altura 200 <i>Right glass door for height 200</i>					

Para altura 200 cm  
con puertas

Height 200 cm with doors

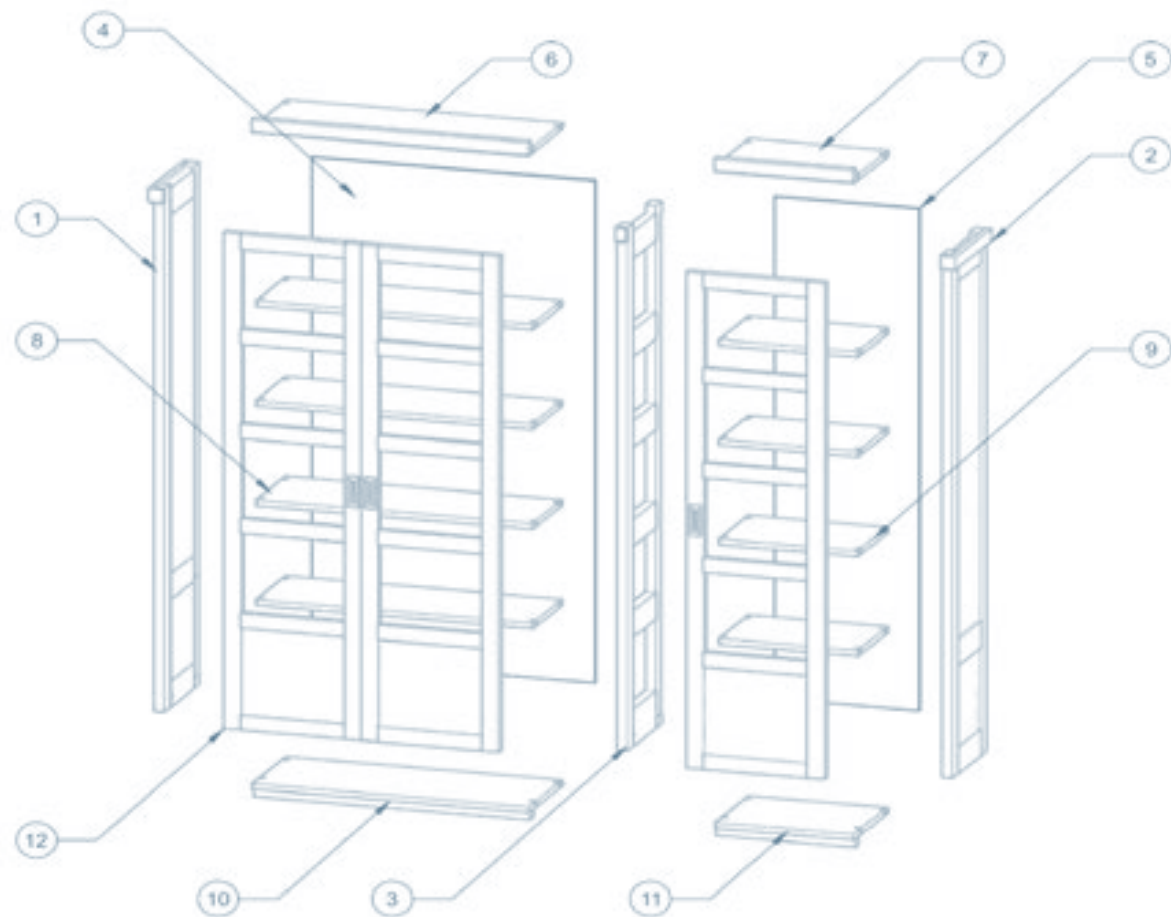







1	EL019 EL022	Costado izquierdo cristal o madera de 200 para puerta
2	EL020 EL024	Costado derecho cristal o madera de 200 para puerta
3	EL026	Costado central de 200 para puertas
4	EL027	Trasera módulo 2 puertas de 200
5	EL028	Trasera módulo 1 puerta altura 200
6	EL045	Techo módulo 2 puertas altura 200 y 240

7	EL044	Techo módulo 1 puerta para altura 200 y 240
8	EL049	Estante módulo 2 puertas x4 en esta composición
9	EL048	Estante módulo 1 puertas x4 en esta composición
10	EL051	Base módulo 2 puertas
11	EL050	Base módulo 1 puerta
12	EL053 EL062	Puerta izquierda o derecha para altura 200, x1 izquierda y x2 derecha en esta composición



Para altura 240 cm  
con puertas

Height 240 cm with doors

				A	B	C	A la Arena
	<b>EL029</b>	Costado izquierdo cristal de 240 <i>Left glass side panel 240</i>	36,5 x 240 x 4,7  0,042 m <sup>2</sup> 1 u	29	32	35	37
	<b>EL030</b>	Costado derecho cristal de 240 <i>Right glass side panel 160</i>	36,5 x 240 x 4,7  0,042 m <sup>2</sup> 1 u	29	32	35	37
	<b>EL032</b>	Costado izquierdo madera de 240 para puertas alta y baja <i>Left wood side panel 240 for upper and lower doors</i>	36,5 x 240 x 4,7  0,042 m <sup>2</sup> 1 u	36	40	43	46
	<b>EL033</b>	Costado izquierdo madera de 240 para puerta baja <i>Left wood side panel 240 for lower door</i>	36,5 x 240 x 4,7  0,042 m <sup>2</sup> 1 u	36	40	43	46
	<b>EL035</b>	Costado derecho madera de 240 para puertas alta y baja <i>Right wood side panel 240 for upper and lower doors</i>	36,5 x 240 x 4,7  0,042 m <sup>2</sup> 1 u	36	40	43	46
	<b>EL036</b>	Costado derecho madera de 240 para puerta baja <i>Right wood side panel 240 for lower door</i>	36,5 x 240 x 4,7  0,042 m <sup>2</sup> 1 u	36	40	43	46
	<b>EL038</b>	Costado central madera de 240 para puertas alta y baja <i>Central wood side panel 240 for upper and lower doors</i>	36,5 x 240 x 4,7  0,042 m <sup>2</sup> 1 u	30	33	36	38







Para altura 240 cm  
con puertas

Height 240 cm with doors

Ref.	Descripción Description	Medidas cm Measure cm	Puntos Points			
			A	B	C	A la Arena
 <b>EL039</b>	Costado central madera de 240 para puerta baja <i>Central wood side panel 240 for lower door</i>	36,5 x 240 x 4,7  0,042 m <sup>2</sup> 1 u	30	33	36	38
 <b>EL040</b>	Trasera módulo 2 puertas de 240 <i>Back panel for 2-door module 240</i>	95 x 232 x 0,6  0,013 m <sup>2</sup> 1 u	17	18	20	21
 <b>EL041</b>	Trasera módulo 1 puerta de 240 <i>Back panel for 1-door module 240</i>	48,6 x 232 x 0,6  0,007 m <sup>2</sup> 1 u	9	10	11	12
 <b>EL044</b>	Techo módulo 1 puerta para altura 200 y 240 <i>Top panel for 1-door module for heights 200 and 240</i>	36 x 46 x 5  0,008 m <sup>2</sup> 1 u	10	11	12	13
 <b>EL045</b>	Techo módulo 2 puerta para altura 200 y 240 <i>Top panel for 2-door module for heights 200 and 240</i>	36 x 93 x 5  0,017 m <sup>2</sup> 1 u	17	19	20	22
 <b>EL046</b>	Divisor módulo 1 puerta para altura 240 <i>Divider panel for 1-door module for height 240</i>	34,3 x 46,6 x 1,9  0,003 m <sup>2</sup> 1 u	9	10	11	12
 <b>EL047</b>	Divisor módulo 2 puertas para altura 240 <i>Divider panel for 2-door module for height 240</i>	34,3 x 93 x 1,9  0,006 m <sup>2</sup> 1 u	15	17	18	20

Para altura 240 cm  
con puertas

Height 240 cm with doors

Ref.	Descripción Description	Medidas cm Measure cm	Puntos Points			
			A	B	C	A la Arena
 <b>EL048</b>	Estante módulo 1 puerta <i>1-door module shelf</i>	30,3 x 46,6 x 1,9  0,003 m <sup>2</sup> 1 u	8	9	10	11
 <b>EL049</b>	Estante módulo 2 puerta <i>2-door module shelf</i>	30,3 x 93 x 1,9  0,005 m <sup>2</sup> 1 u	15	16	18	19
 <b>EL050</b>	Base módulo 1 puerta <i>1-door module base</i>	35 x 46,6 x 5  0,008 m <sup>2</sup> 1 u	12	13	14	15
 <b>EL051</b>	Base módulo 2 puerta <i>2-door module base</i>	35 x 93 x 5  0,017 m <sup>2</sup> 1 u	21	23	25	27
 <b>EL052</b>	Puerta alta cristal para altura de 160 y 240 <i>High glass door for heights 160 and 240</i>	46,2 x 149,7 x 2,5  0,018 m <sup>2</sup> 1 u	15	17	18	20
 <b>EL054</b>	Puerta baja cristal para altura de 88 y 240 <i>Low glass door for heights 88 and 240</i>	46,2 x 77,6 x 2,5  0,009 m <sup>2</sup> 1 u	11	12	13	14
 <b>EL055</b>	Puerta baja madera para altura de 88 y 240 <i>Low wood door for heights 88 and 240</i>	46,2 x 77,6 x 2,5  0,009 m <sup>2</sup> 1 u	18	20	22	23



Altura 240 cm con puertas alta y baja  
Height 240 cm with upper and lower doors

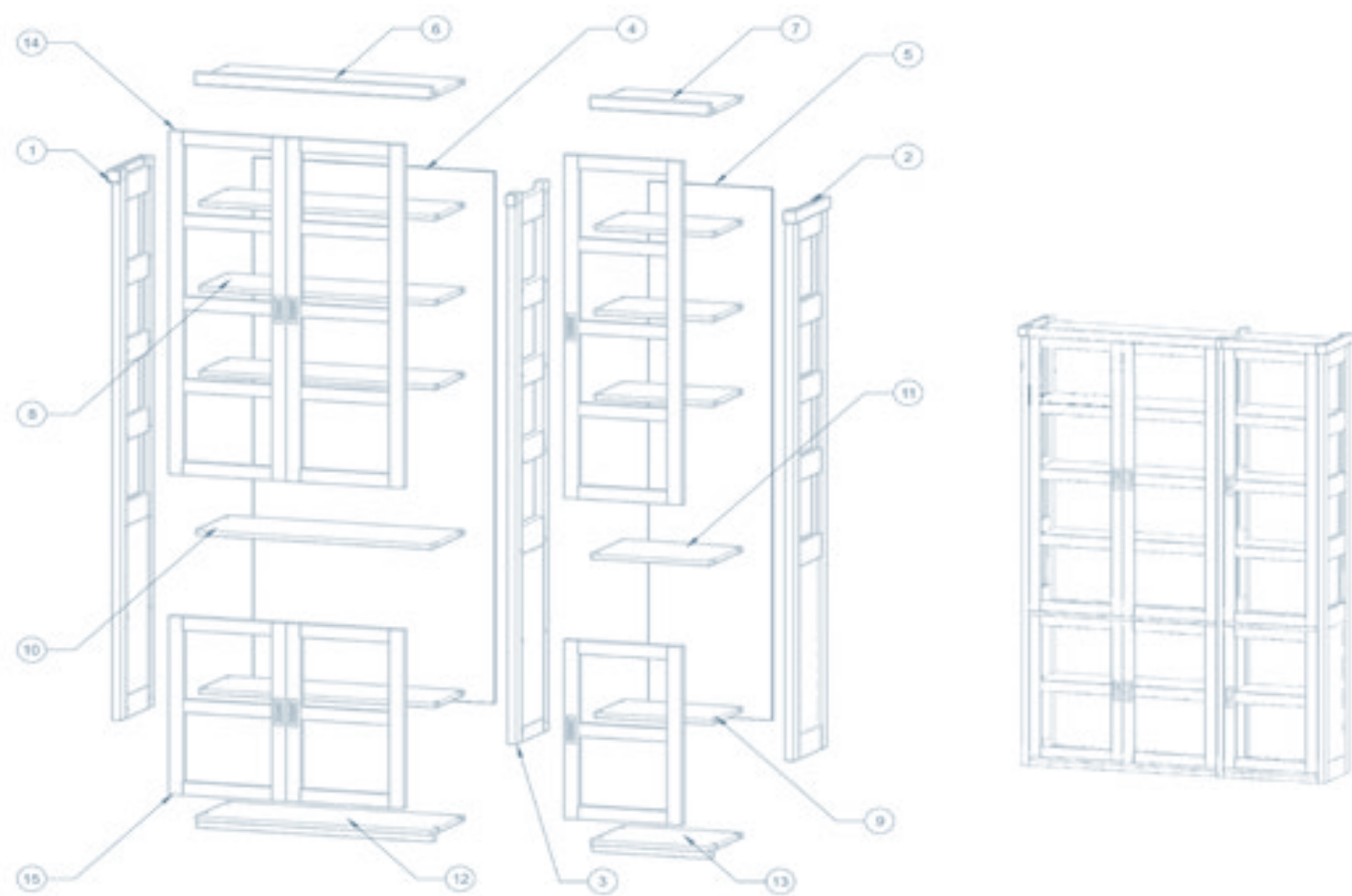

1	EL029 EL032	Costado izquierdo cristal o madera de 240 para puertas alta y baja
2	EL030 EL035	Costado derecho cristal o madera de 240 para puertas alta y baja
3	EL038	Costado central de 240 para puertas
4	EL040	Trasera módulo 2 puertas de 240
5	EL041	Trasera módulo 1 puerta altura 240
6	EL045	Techo módulo 2 puertas altura 200 y 240
7	EL044	Techo módulo 1 puerta altura 200 y 240
8	EL049	Estante módulo 2 puertas, x4 en esta composición

9	EL048	Estante módulo 1 puertas, x4 en esta composición
10	EL047	Divisor módulo 2 puertas altura 240
11	EL046	Divisor módulo 1 puerta altura 240
12	EL051	Base módulo 2 puertas
13	EL050	Base módulo 1 puerta
14	EL052	Puerta cristal alta para altura 160 y 240, x3 en esta composición
15	EL054 EL055	Puerta cristal o madera baja para altura 88 y 240, x3 en esta composición

Altura 240 cm con puerta baja  
Height 240 cm with lower door

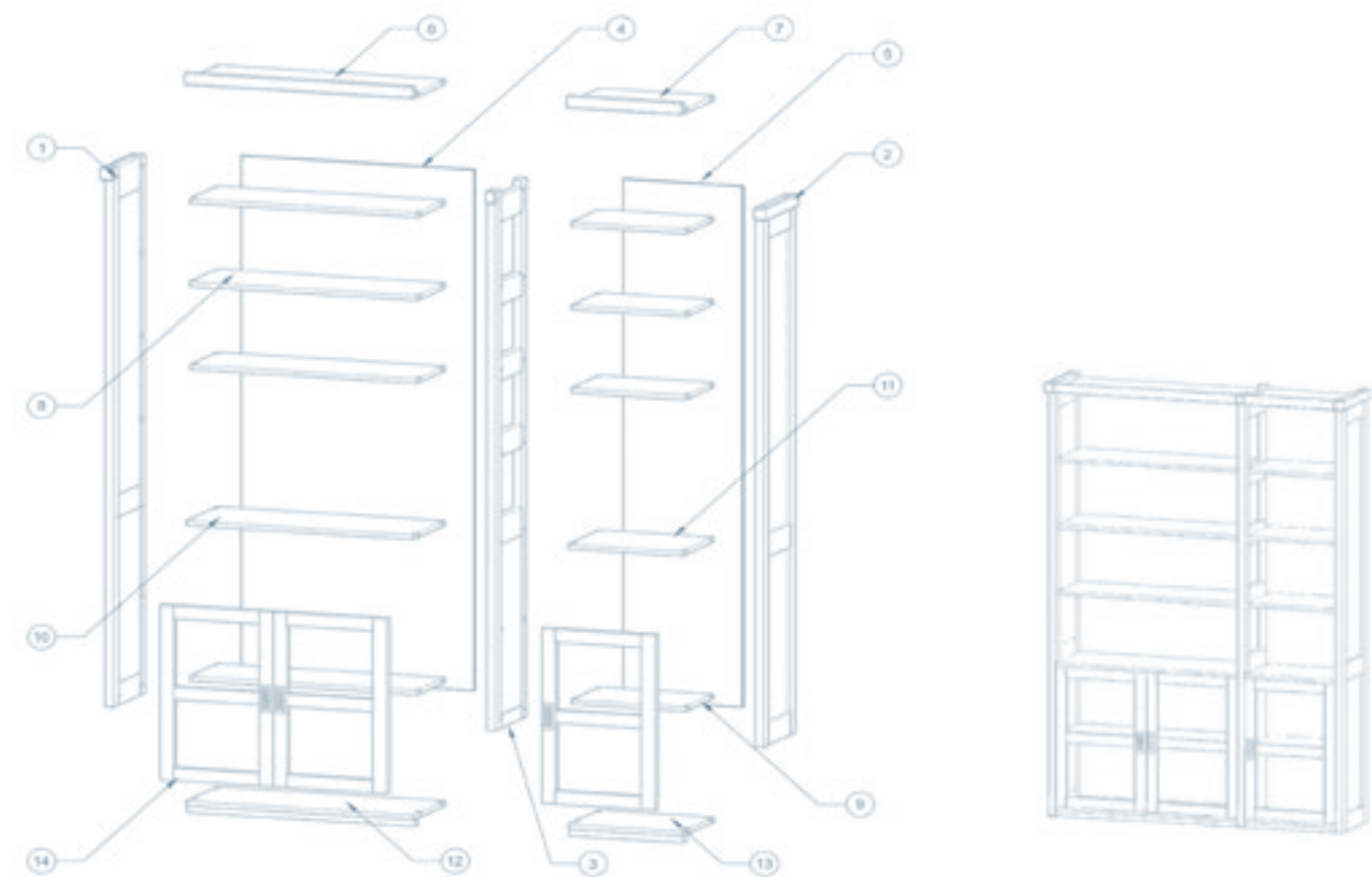































1	EL033	Costado izquierdo madera de 240 para puertas baja
2	EL036	Costado derecho madera de 240 para puerta baja
3	EL039	Costado central de 240 para puerta baja
4	EL040	Trasera módulo 2 puertas de 240
5	EL041	Trasera módulo 1 puerta altura 240
6	EL045	Techo módulo 2 puertas altura 200 y 240
7	EL044	Techo módulo 1 puerta altura 200 y 240
8	EL049	Estante módulo 2 puertas, x4 en esta composición

9	EL048	Estante módulo 1 puertas, x4 en esta composición
10	EL047	Divisor módulo 2 puertas altura 240
11	EL046	Divisor módulo 1 puerta altura 240
12	EL051	Base módulo 2 puertas
13	EL050	Base módulo 1 puerta
14	EL054 EL055	Puerta cristal o madera baja para altura 88 y 240, x3 en esta composición

Para altura  
88 cm sin puertas  
Height 88 cm without doors

Ref.	Descripción Description	Medidas cm Measure cm	Puntos Points			
			A	B	C	A la Arena
 <b>EL001</b>	Costado izquierdo madera de 88 <i>Left wood side panel 88</i>	35 x 84,9 x 3,2  0,015  1 u	14	16	17	18
 <b>EL003</b>	Costado derecho madera de 88 <i>Right wood side panel 88</i>	35 x 84,9 x 3,2  0,015  1 u	14	16	17	18
 <b>EL005</b>	Costado central madera de 88 <i>Central wood side panel 88</i>	35 x 84,9 x 3,2  0,015  1 u	17	18	20	21
 <b>EL007</b>	Trasera módulo 2 puertas de 88 <i>Back panel for 2-door module 88</i>	95 x 80 x 0,6  0,005  1 u	6	7	8	9
 <b>EL008</b>	Trasera módulo 1 puerta de 88 <i>Back panel for 1-door module 88</i>	48,6 x 80 x 0,6  0,002  1 u	3	4	5	6
 <b>EL042</b>	Techo módulo 1 puerta para altura 88 y 160 <i>Top panel for 1-door module for heights 88 and 160</i>	34,3 x 46,6 x 1,9  0,003  1 u	9	10	11	12
 <b>EL043</b>	Techo módulo 2 puerta para altura 88 y 160 <i>Top panel for 2-door module for heights 88 and 160</i>	34,3 x 93 x 1,9  0,006  1 u	15	17	18	20

Para altura  
88 cm sin puertas  
Height 88 cm without doors

Ref.	Descripción Description	Medidas cm Measure cm	Puntos Points			
			A	B	C	A la Arena
 <b>EL048</b>	Estante módulo 1 puerta <i>1-door module shelf</i>	30,3 x 46,6 x 1,9  0,003  1 u	8	9	10	11
 <b>EL049</b>	Estante módulo 2 puerta <i>2-door module shelf</i>	30,3 x 93 x 1,9  0,005  1 u	15	16	18	19
 <b>EL050</b>	Base módulo 1 puerta <i>1-door module base</i>	35 x 46,6 x 5  0,008  1 u	12	13	14	15
 <b>EL051</b>	Base módulo 2 puerta <i>2-door module base</i>	35 x 93 x 5  0,017  1 u	21	23	25	27
 <b>EL056</b>	Tapa 1 módulo de 1 puerta para altura 88 y 160 <i>Top panel for 1-door module for heights 88 and 160</i>	56 x 38 x 3  0,007  1 u	11	12	13	14
 <b>EL057</b>	Tapa 1 módulo de 2 puertas para altura 88 y 160 <i>Top panel for 2-door module for heights 88 and 160</i>	105 x 39 x 3  0,013  1 u	19	20	22	24
 <b>EL058</b>	Tapa 1 módulo de 1 puerta y 1 de 2 puertas para altura de 88 y 160 <i>Top panel for 1-door module plus 2-door module for heights 88 and 160</i>	152 x 38 x 3  0,018  1 u	26	29	31	33
 <b>EL059</b>	Tapa 2 módulos de 2 puertas para altura de 88 y 160 <i>Top panel for 2-door double module for heights 88 and 160</i>	198 x 38 x 3  0,023  1 u	33	37	40	43
 <b>EL060</b>	Tapa 1 módulo de 1 puerta y 2 de 2 puertas para altura 88 y 160 <i>Top panel for 1-door module plus 2-door double module for heights 88 and 160</i>	248 x 38 x 3  0,029  1 u	53	58	62	67
 <b>EL061</b>	Tapa 3 módulos de 2 puertas para altura de 88 y 160 <i>Top panel for 3-door double module for heights 88 and 160</i>	295 x 38 x 3  0,034  1 u	62	68	73	79

Para altura  
88 cm sin puertas  
Height 88 cm without doors

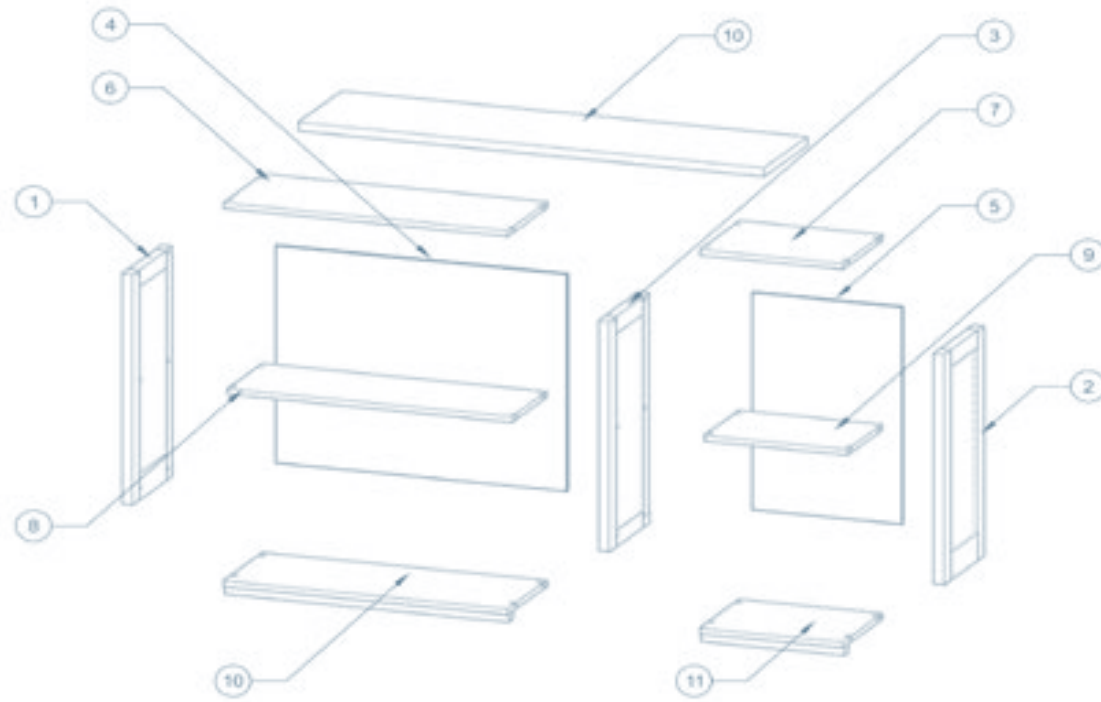





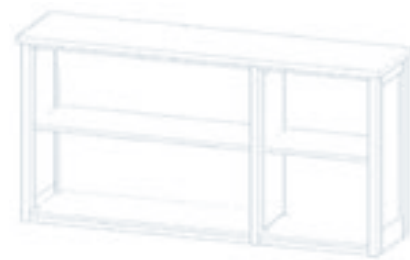















1	EL001	Costado izquierdo de 88
2	EL003	Costado derecho de 88
3	EL005	Costado central de 88
4	EL007	Trasera módulo 2 puertas altura 88
5	EL008	Trasera módulo 1 puerta altura 88
6	EL043	Techo módulo 2 puertas altura 88 y 160

7	EL042	Techo módulo 1 puertas altura 88 y 160
8	EL049	Estante módulo 2 puertas
9	EL048	Estante módulo 1 puerta
10	EL051	Base módulo 2 puertas
11	EL050	Base módulo 1 puerta
12	EL058	Tapa para altura 88 y 160, largo según número de módulos



Para altura  
160 cm sin puertas  
Height 160 cm without doors

				A	B	C	A la Arena
	<b>EL011</b>	Costado izquierdo madera de 160 <i>Left wood side panel 160</i>	35 x 157 x 3,2  0,020  1 u	24	26	28	30
	<b>EL013</b>	Costado derecho madera de 160 <i>Right wood side panel 160</i>	35 x 157 x 3,2  0,020  1 u	24	26	28	30
	<b>EL015</b>	Costado central de 160 <i>Central wood side panel 160</i>	35 x 157 x 3,2  0,020  1 u	15	17	18	20
	<b>EL017</b>	Trasera módulo 2 puertas de 160 <i>Back panel for 2-door module 160</i>	95 x 152,1 x 0,6  0,009  1 u	12	13	14	15
	<b>EL018</b>	Trasera módulo 1 puerta de 160 <i>Back panel for 1-door module 160</i>	48,6 x 152,1 x 0,6  0,005  1 u	6	7	8	9
	<b>EL042</b>	Techo módulo 1 puerta para altura 88 y 160 <i>Top panel for 1-door module for heights 88 and 160</i>	34,3 x 46,6 x 1,9  0,003  1 u	4	5	6	7
	<b>EL043</b>	Techo módulo 2 puerta para altura 88 y 160 <i>Top panel for 2-door module for heights 88 and 160</i>	34,3 x 93 x 1,9  0,006  1 u	5	6	7	8

Para altura  
160 cm sin puertas  
Height 160 cm without doors

Ref.	Descripción Description	Medidas cm Measure cm	Puntos Points			
			A	B	C	A la Arena
 <b>EL048</b>	Estante módulo 1 puerta 1-door module shelf	30,3 x 46,6 x 1,9  0,003  1 u	8	9	10	11
 <b>EL049</b>	Estante módulo 2 puerta 2-door module shelf	30,3 x 93 x 1,9  0,005  1 u	15	16	18	19
 <b>EL050</b>	Base módulo 1 puerta 1-door module base	35 x 46,6 x 5  0,008  1 u	12	13	14	15
 <b>EL051</b>	Base módulo 2 puertas 2-door module base	35 x 93 x 5  0,017  1 u	21	23	25	27
 <b>EL056</b>	Tapa 1 módulo de 1 puerta para altura 88 y 160 Top panel for 1-door module for heights 88 and 160	56 x 38 x 3  0,007  1 u	11	12	13	14
 <b>EL057</b>	Tapa 1 módulo de 2 puertas para altura 88 y 160 Top panel for 2-door module for heights 88 and 160	105 x 39 x 3  0,013  1 u	19	20	22	24
 <b>EL058</b>	Tapa 1 módulo de 1 puerta y 1 de 2 puertas para altura de 88 y 160 Top panel for 1-door module plus 2-door module for heights 88 and 160	152 x 38 x 3  0,018  1 u	26	29	31	33
 <b>EL059</b>	Tapa 2 módulos de 2 puertas para altura de 88 y 160 Top panel for 2-door double module for heights 88 and 160	198 x 38 x 3  0,023  1 u	33	37	40	43
 <b>EL060</b>	Tapa 1 módulo de 1 puerta y 2 de 2 puertas para altura 88 y 160 Top panel for 1-door module plus 2-door double mod	248 x 38 x 3  0,029  1 u	53	58	62	67
 <b>EL061</b>	Tapa 3 módulos de 2 puertas para altura de 88 y 160 Top panel for 3-door double module for heights 88 and 160	295 x 38 x 3  0,034  1 u	62	68	73	79

Para altura  
160 cm sin puertas  
Height 160 cm without doors

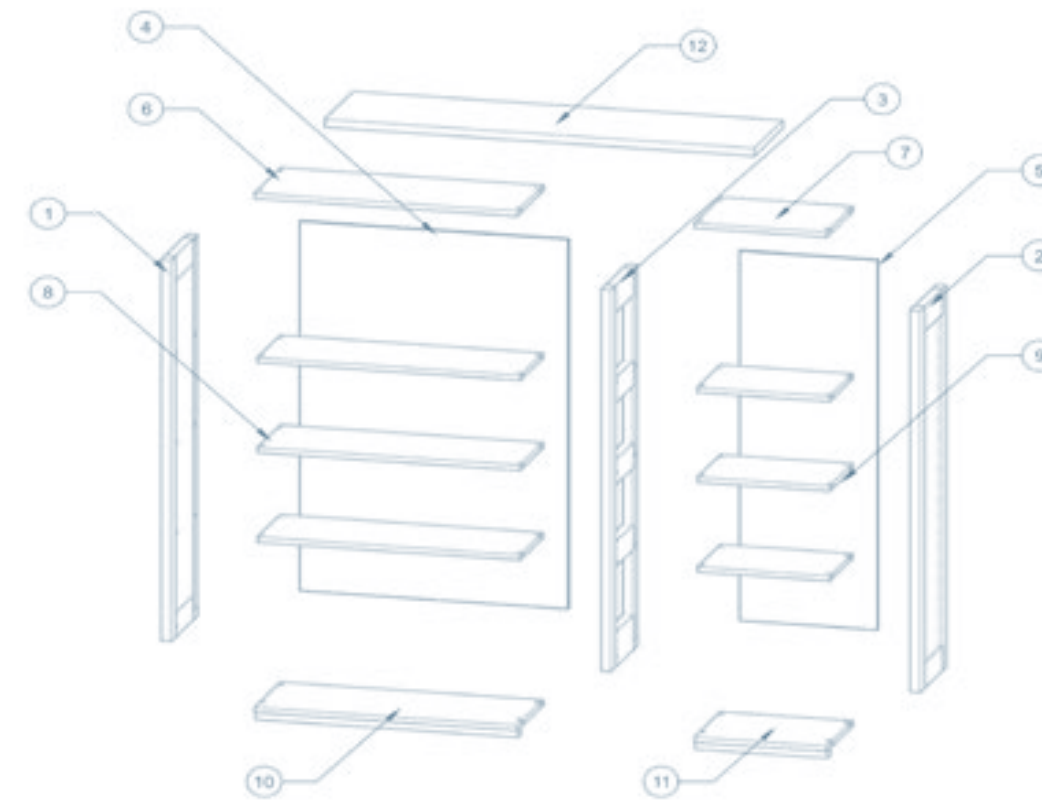

































1	<b>EL011</b>	Costado izquierdo madera de 160
2	<b>EL013</b>	Costado derecho madera de 160
3	<b>EL015</b>	Costado central de 88
4	<b>EL017</b>	Trasera módulo 2 puertas altura 88
5	<b>EL018</b>	Trasera módulo 1 puerta altura 88
6	<b>EL043</b>	Techo módulo 2 puertas altura 88 y 160

7	<b>EL042</b>	Techo módulo 1 puertas altura 88 y 160
8	<b>EL049</b>	Estante módulo 2 puertas
9	<b>EL048</b>	Estante módulo 1 puerta
10	<b>EL051</b>	Base módulo 2 puertas
11	<b>EL050</b>	Base módulo 1 puerta
12	<b>EL058</b>	Tapa para altura 88 y 160, largo según número de módulos



Para altura  
200 cm sin puertas  
Height 200 cm without doors

Ref.	Descripción Description	Medidas cm Measure cm	Puntos Points			
			A	B	C	A la Arena
 <b>EL021</b>	Costado izquierdo madera de 200 <i>Left wood side panel 200</i>	36,5 x 201 x 4,7  0,035  1 u	26	28	30	33
 <b>EL023</b>	Costado derecho madera de 200 <i>Right wood side panel 200</i>	36,5 x 201 x 4,7  0,035  1 u	26	28	30	33
 <b>EL025</b>	Costado central de 200 <i>Central wood side panel 200</i>	36,5 x 201 x 4,7  0,035  1 u	32	35	38	40
 <b>EL027</b>	Trasera módulo 2 puertas de 200 <i>Back panel for 2-door module 200</i>	95 x 192 x 0,6  0,011  1 u	14	16	17	18
 <b>EL028</b>	Trasera módulo 1 puerta de 200 <i>Back panel for 1-door module 200</i>	48,6 x 192 x 0,6  0,003  1 u	7	8	9	10
 <b>EL044</b>	Techo módulo 1 puerta para altura 200 y 240 <i>Top panel for 1-door module for heights 200 and 240</i>	36 x 46 x 5  0,006  1 u	10	11	12	13
 <b>EL045</b>	Techo módulo 2 puerta para altura 200 y 240 <i>Top panel for 2-door module for heights 200 and 240</i>	36 x 93 x 5  0,017  1 u	17	19	20	22
 <b>EL048</b>	Estante módulo 1 puerta <i>1-door module shelf</i>	30,3 x 46,6 x 1,9  0,003  1 u	8	9	10	11
 <b>EL049</b>	Estante módulo 2 puerta <i>2-door module shelf</i>	30,3 x 93 x 1,9  0,005  1 u	15	16	18	19
 <b>EL050</b>	Base módulo 1 puerta <i>1-door module base</i>	35 x 46,6 x 5  0,008  1 u	12	13	14	15
 <b>EL051</b>	Base módulo 2 puertas <i>2-door module base</i>	35 x 93 x 5  0,017  1 u	21	23	25	27

Para altura  
200 cm sin puertas  
Height 200 cm without doors

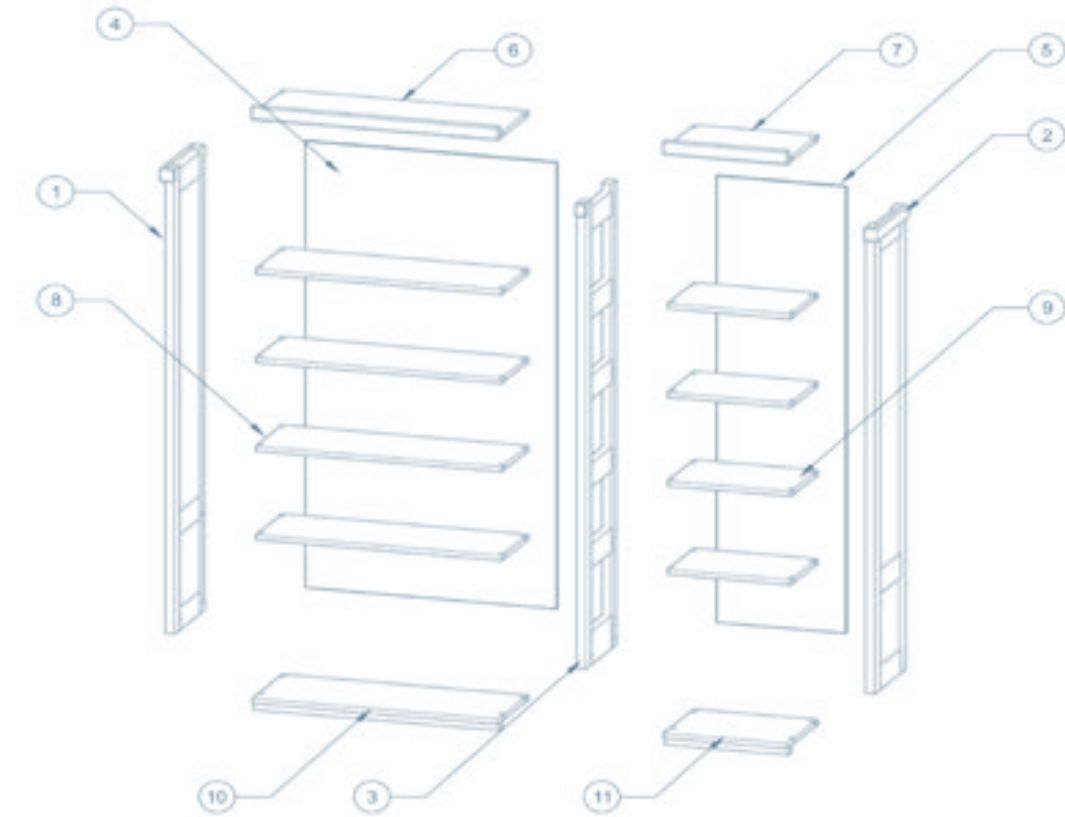



















1	<b>EL021</b>	Costado izquierdo madera de 200
2	<b>EL023</b>	Costado derecho madera de 200
3	<b>EL025</b>	Costado central de 200
4	<b>EL027</b>	Trasera módulo 2 puertas altura 200
5	<b>EL028</b>	Trasera módulo 1 puerta altura 200
6	<b>EL045</b>	Techo módulo 2 puertas altura 200 y 240

7	<b>EL044</b>	Techo módulo 1 puertas altura 200 y 240
8	<b>EL049</b>	Estante módulo 2 puertas, x4 en esta composición
9	<b>EL048</b>	Estante módulo 1 puertas, x4 en esta composición
10	<b>EL051</b>	Base módulo 2 puertas
11	<b>EL050</b>	Base módulo 1 puerta



Para altura  
240 cm sin puertas  
Height 240 cm without doors

Ref.	Descripción Description	Medidas cm Measure cm	Puntos Points			
			A	B	C	A la Arena
 <b>EL031</b>	Costado izquierdo madera de 240 <i>Left wood side panel 240</i>	36,5 x 240 x 4,7  0,042  1 u	29	32	35	37
 <b>EL034</b>	Costado derecho madera de 240 <i>Right wood side panel 240</i>	36,5 x 240 x 4,7  0,042  1 u	29	32	35	37
 <b>EL037</b>	Costado central de 240 <i>Central wood side panel 240</i>	36,5 x 240 x 4,7  0,042  1 u	36	40	43	46
 <b>EL040</b>	Trasera módulo 2 puertas de 240 <i>Back panel for 2-door module 240</i>	95 x 232 x 0,6  0,013  1 u	17	18	20	21
 <b>EL041</b>	Trasera módulo 1 puerta de 240 <i>Back panel for 1-door module 240</i>	48,6 x 232 x 0,6  0,007  1 u	9	10	11	12
 <b>EL044</b>	Techo módulo 1 puerta para altura 200 y 240 <i>Top panel for 1-door module for heights 200 and 240</i>	36 x 46 x 5  0,008  1 u	10	11	12	13

Para altura  
240 cm sin puertas  
Height 240 cm without doors

Ref.	Descripción Description	Medidas cm Measure cm	Puntos Points			
			A	B	C	A la Arena
 <b>EL045</b>	Techo módulo 2 puerta para altura 200 y 240 <i>Top panel for 2-door module for heights 200 and 240</i>	36 x 93 x 5  0,017  1 u	17	19	20	22
 <b>EL046</b>	Divisor módulo 1 puerta para altura 240 <i>Divider panel for 1-door module for height 240</i>	34,3 x 46,6 x 1,9  0,003  1 u	9	10	11	12
 <b>EL047</b>	Divisor módulo 2 puertas para altura 240 <i>Divider panel for 2-door module for height 240</i>	34,3 x 93 x 1,9  0,006  1 u	15	17	18	20
 <b>EL048</b>	Estante módulo 1 puerta 1-door module shelf	30,3 x 46,6 x 1,9  0,003  1 u	8	9	10	11
 <b>EL049</b>	Estante módulo 2 puerta 2-door module shelf	30,3 x 93 x 1,9  0,005  1 u	15	16	18	19
 <b>EL050</b>	Base módulo 1 puerta 1-door module base	35 x 46,6 x 5  0,008  1 u	12	13	14	15
 <b>EL051</b>	Base módulo 2 puerta 2-door module base	35 x 93 x 5  0,017  1 u	21	23	25	27

Para altura  
**240 cm sin puertas**  
*Height 240 cm without doors*

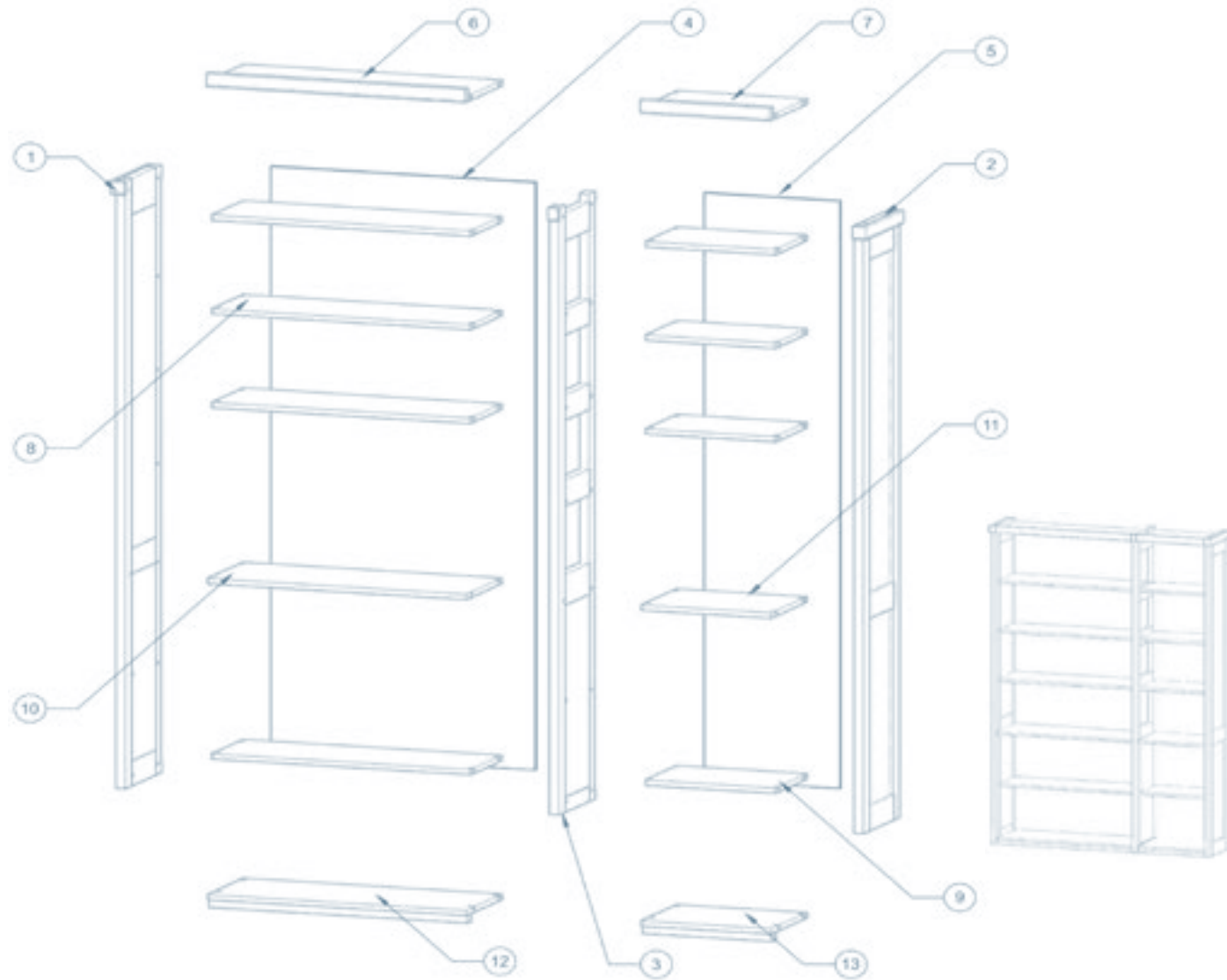

1	EL031	Costado izquierdo madera de 240
2	EL034	Costado derecho madera de 240
3	EL037	Costado central de 240
4	EL040	Trasera módulo 2 puertas altura 240
5	EL041	Trasera módulo 1 puerta altura 240
6	EL045	Techo módulo 2 puertas altura 200 y 240

7	EL044	Techo módulo 1 puertas altura 200 y 240
8	EL049	Estante módulo 2 puertas, x4 en esta composición
9	EL048	Estante módulo 1 puerta, x4 en esta composición
10	EL047	Divisor módulo 2 puertas altura 240
11	EL046	Divisor módulo 1 puertas altura 240
12	EL051	Base módulo 2 puertas
13	EL050	Base módulo 1 puerta

# COLECCIÓN AMBERES

## Collection AMBERES

COMEDORES  
 DINNING ROOM



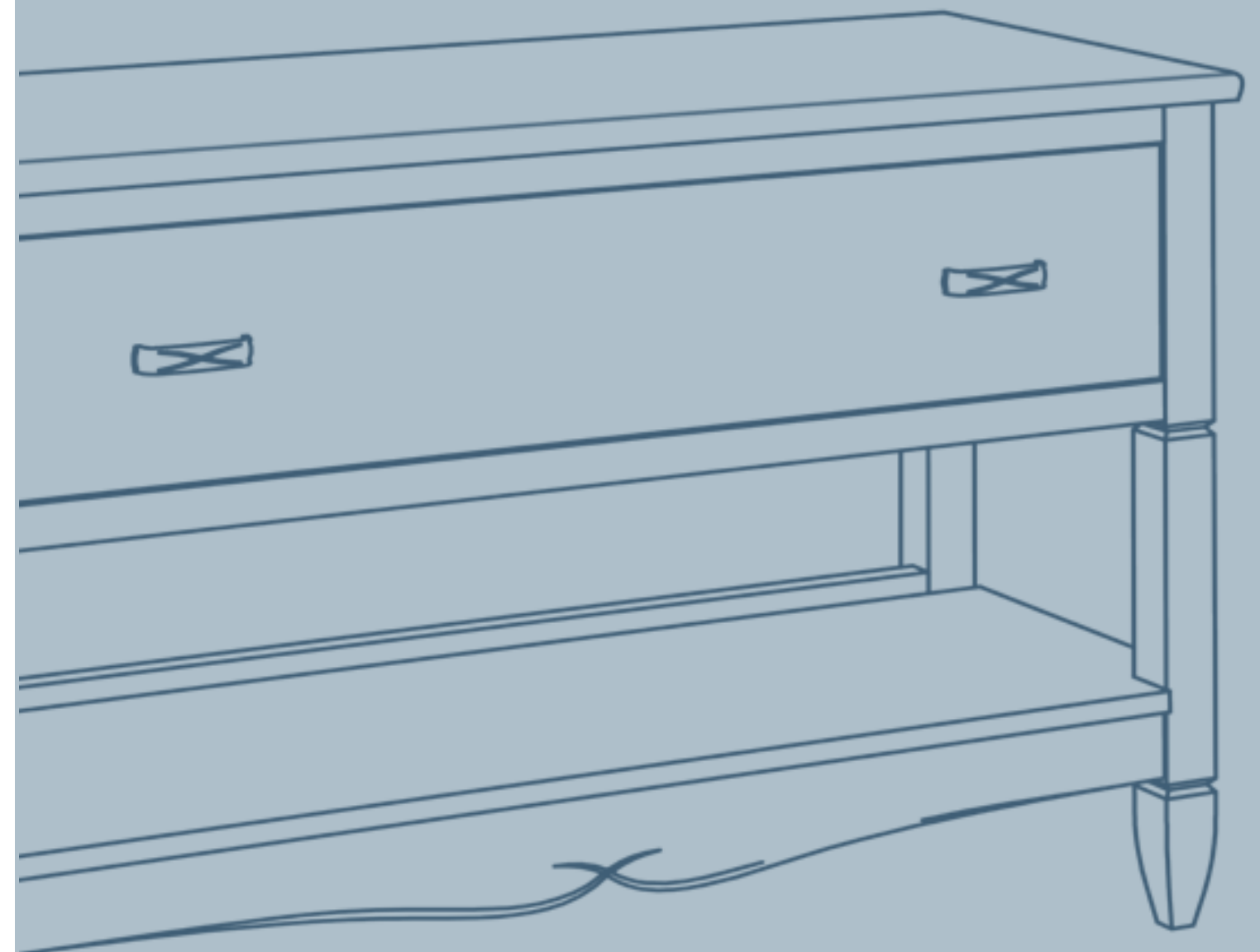















AMBERES



**COLECCIÓN Amberes** Ref.  
Collection Amberes

	Ref.	Descripción Description	Medidas cm Measure cm	Puntos Points			
				A	B	C	A la Arena
	<b>AC001</b>	Aparador 2 puertas corredera de 108 Amberes <i>2-Doors sliding sideboard Amberes 108</i>	108 x 88 x 44  0,426  1 u	<b>172</b>	<b>189</b>	<b>204</b>	<b>219</b>
	<b>AC002</b>	Aparador 2 puertas corredera de 188 Amberes <i>2-Doors sliding sideboard Amberes 1888</i>	188 x 88 x 44  0,742  1 u	<b>260</b>	<b>285</b>	<b>308</b>	<b>330</b>
	<b>AC003</b>	Vajillero 4 puertas (cristal) y 4 cajones Amberes <i>4-door Dish rack (glass) and 4 drawers Amberes</i>	113 x 138 x 44  0,697  1 u	<b>232</b>	<b>255</b>	<b>276</b>	<b>295</b>
	<b>AC004</b>	Vajillero 4 puertas (cristal-madera) y 4 cajones Amberes <i>4-door Dish rack (glass and wood) and 4 drawers Amberes</i>	113 x 138 x 44  0,697  1 u	<b>232</b>	<b>255</b>	<b>276</b>	<b>295</b>
	<b>AC005</b>	Bureau Amberes <i>Amberes Bureau</i>	112 x 148 x 44  0,735  2 u	<b>284</b>	<b>312</b>	<b>337</b>	<b>361</b>
	<b>AC006</b>	Mesa TV de 153 Amberes <i>T.V. table 153 Amberes</i>	153 x 57 x 44  0,397  1 u	<b>173</b>	<b>191</b>	<b>206</b>	<b>221</b>
	<b>AC007</b>	Mesa TV de 188 Amberes <i>T.V. table 188 Amberes</i>	188 x 59 x 44  0,505  1 u	<b>214</b>	<b>235</b>	<b>254</b>	<b>272</b>
	<b>AC008</b>	Librero Amberes <i>Bookcase Amberes</i>	112 x 200 x 44  0,994  2 u	<b>248</b>	<b>273</b>	<b>295</b>	<b>316</b>

**COLECCIÓN Amberes** Ref.  
Collection Amberes

	Ref.	Descripción Description	Medidas cm Measure cm	Puntos Points			
				A	B	C	A la Arena
	<b>AC009</b>	Vitrina Amberes <i>Display case Amberes</i>	112 x 200 x 44  0,994  1 u	<b>196</b>	<b>215</b>	<b>233</b>	<b>249</b>
	<b>AC010</b>	Vitrina con cajonera Amberes <i>Drawers display case Amberes</i>	112 x 200 x 44  0,994  1 u	<b>244</b>	<b>268</b>	<b>290</b>	<b>310</b>
	<b>AC011</b>	Vitrina con bajo Amberes <i>Low display case Amberes</i>	112 x 210 x 44  1,044  1 u	<b>309</b>	<b>340</b>	<b>367</b>	<b>393</b>
	<b>AC012</b>	Vitrina puertas corredera Amberes <i>Showcase sliding doors Amberes</i>	192 x 210 x 44  1,789  2 u	<b>480</b>	<b>527</b>	<b>570</b>	<b>610</b>
	<b>AC013</b>	Mesa de centro elevable Amberes <i>Elevating coffee table Amberes</i>	110 x 46 x 65  0,328  1 u	<b>136</b>	<b>149</b>	<b>161</b>	<b>173</b>
	<b>AC014</b>	Bajo cajón Amberes <i>Under the drawer Amberes</i>	108 x 75 x 44  0,359  1 u	<b>111</b>	<b>122</b>	<b>132</b>	<b>141</b>









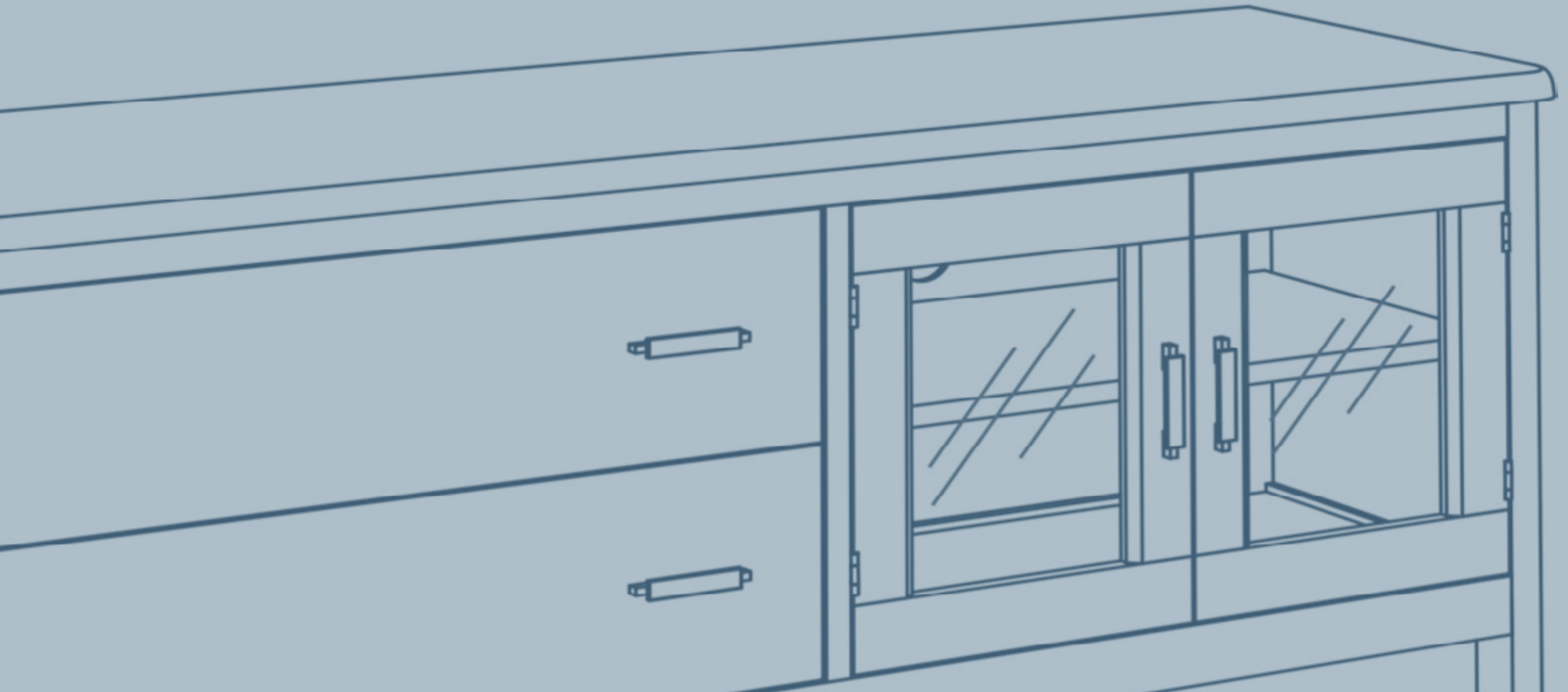









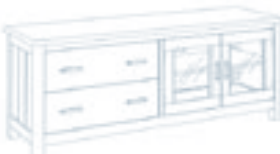

# COLECCIÓN CERDEÑA

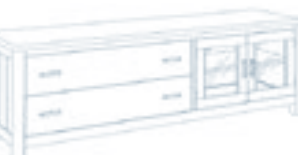
## Collection CERDEÑA

















COMEDORES  
DINNING ROOM



**COLECCIÓN Cerdeña** Ref.  
Collection Cerdeña

	Ref.	Descripción Description	Medidas cm Measure cm	Puntos Points			
				A	B	C	A la Arena
	<b>CC001</b>	Recibidor Cerdeña Cerdeña hall unit	91 x 197 x 39  0,838  2 u	<b>137</b>	<b>150</b>	<b>162</b>	<b>174</b>
	<b>CC002</b>	Aparador de 120 Cerdeña Sideboard Cerdeña 120	120 x 86 x 43  0,453  1 u	<b>181</b>	<b>199</b>	<b>215</b>	<b>230</b>
	<b>CC003</b>	Aparador de 190 Cerdeña Sideboard Cerdeña 190	190 x 86 x 43  0,713  1 u	<b>256</b>	<b>281</b>	<b>304</b>	<b>325</b>
	<b>CC004</b>	Mesa T.V. de 138 Cerdeña T.V. table 138 Cerdeña	138 x 61 x 43  0,369  1 u	<b>163</b>	<b>180</b>	<b>194</b>	<b>208</b>
	<b>CC005</b>	Mesa T.V. de 171 Cerdeña T.V. table 171 Cerdeña	171 x 61 x 43  0,458  1 u	<b>184</b>	<b>202</b>	<b>218</b>	<b>234</b>
	<b>CC006</b>	Librero Cerdeña Bookcase Cerdeña	138 x 200 x 43  1,211  2 u	<b>370</b>	<b>407</b>	<b>439</b>	<b>470</b>
	<b>CC007</b>	Vitrina 6 puertas Cerdeña Cerdeña 6 doors showcase	124 x 203 x 44  1,130  2 u	<b>305</b>	<b>336</b>	<b>362</b>	<b>388</b>

**COLECCIÓN Cerdeña** Ref.  
Collection Cerdeña

	Ref.	Descripción Description	Medidas cm Measure cm	Puntos Points			
				A	B	C	A la Arena
	<b>CC008</b>	Vitrina 6 puertas con cajonera Cerdeña 6 doors with chest of drawers Cerdeña	124 x 203 x 44  1,130  2 u	<b>354</b>	<b>390</b>	<b>421</b>	<b>451</b>
	<b>CC009</b>	Vitrina 2 puertas Cerdeña 2-Door display case Cerdeña	124 x 211 x 43  1,148  2 u	<b>313</b>	<b>344</b>	<b>371</b>	<b>397</b>
	<b>CC010</b>	Vitrina puertas correderas Cerdeña Showcase sliding doors Cerdeña	193 x 204 x 43  1,727  2 u	<b>492</b>	<b>541</b>	<b>584</b>	<b>625</b>
	<b>CC011</b>	Mesa de centro elevable Cerdeña Elevating coffee table Cerdeña	115 x 46 x 60  0,324  1 u	<b>109</b>	<b>120</b>	<b>130</b>	<b>139</b>
	<b>CC012</b>	Mesa terminal Cerdeña End table Cerdeña	58 x 58 x 43  0,148  1 u	<b>46</b>	<b>51</b>	<b>55</b>	<b>59</b>
	<b>CC013</b>	Bajo cajón Cerdeña Under the drawer Cerdeña	91 x 57 x 39  0,206  1 u	<b>81</b>	<b>89</b>	<b>96</b>	<b>103</b>

# COLECCIÓN VOLGA

**Collection VOLGA**

COMEDORES  
DINNING ROOM

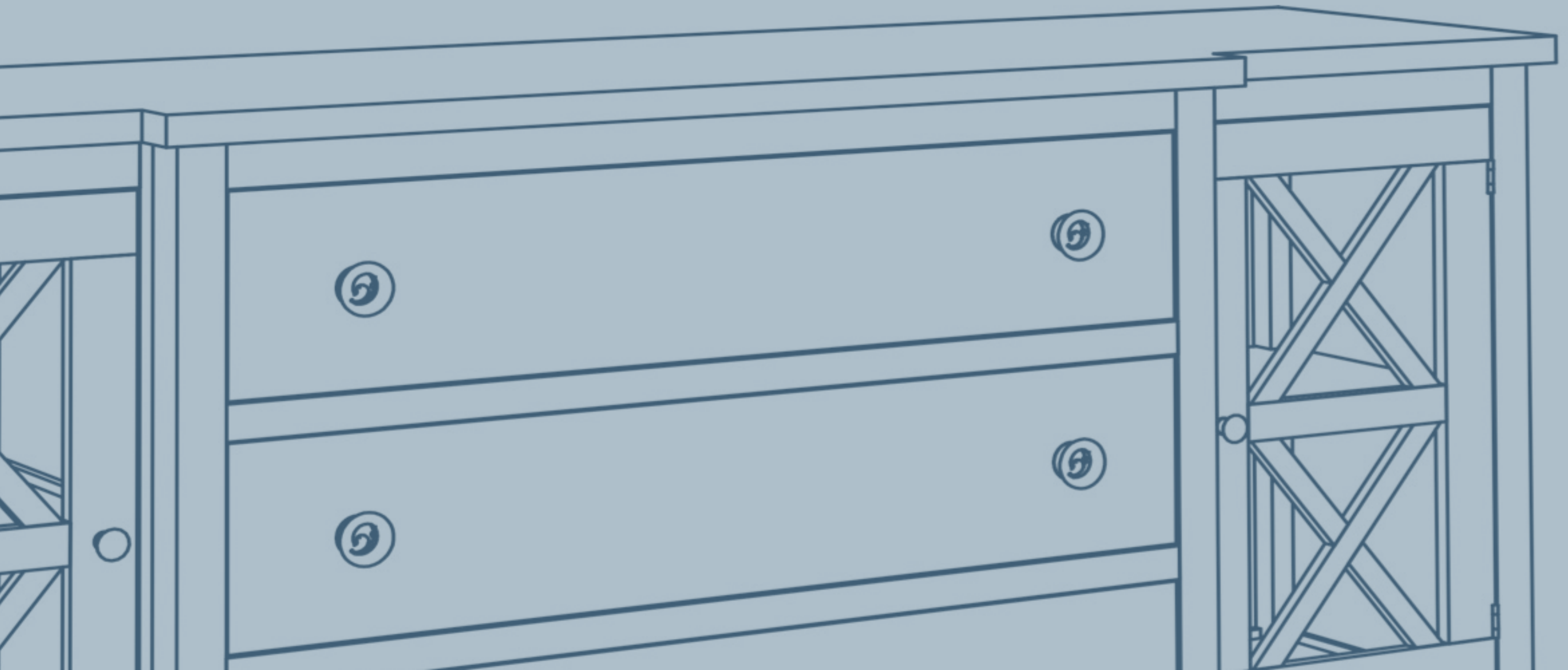

**COLECCIÓN Volga**  
Collection Volga

Ref.	Descripción Description	Medidas cm Measure cm	Puntos Points			
			A	B	C	A la Arena
 <b>XC001</b>	Aparador Volga Volga Sideboard	197 x 93 x 46	<b>295</b>	<b>325</b>	<b>351</b>	<b>375</b>
		 0,846  1 u				
 <b>XC002</b>	Mesa T.V. Volga T.V. table Volga	169 x 65 x 46	<b>191</b>	<b>210</b>	<b>227</b>	<b>243</b>
		 0,503  1 u				
 <b>XC003</b>	Librero Volga Bookcase Volga	88 x 206 x 45	<b>191</b>	<b>210</b>	<b>227</b>	<b>242</b>
		 0,819  1 u				
 <b>XC004</b>	Vitrina Volga Display case Volga	116 x 205 x 45	<b>292</b>	<b>321</b>	<b>347</b>	<b>371</b>
		 1,074  1 u				
 <b>XC005</b>	Mesa de centro Volga Coffee table Volga	112 x 47 x 112	<b>176</b>	<b>194</b>	<b>209</b>	<b>224</b>
		 0,579  1 u				
 <b>XC006</b>	Mesa de centro elevable Volga Elevating coffee table Volga	112 x 48 x 66	<b>150</b>	<b>165</b>	<b>178</b>	<b>191</b>
		 0,342  1 u				

# COLECCIÓN VERONA

## Collection VERONA

COMEDORES  
DINNING ROOM

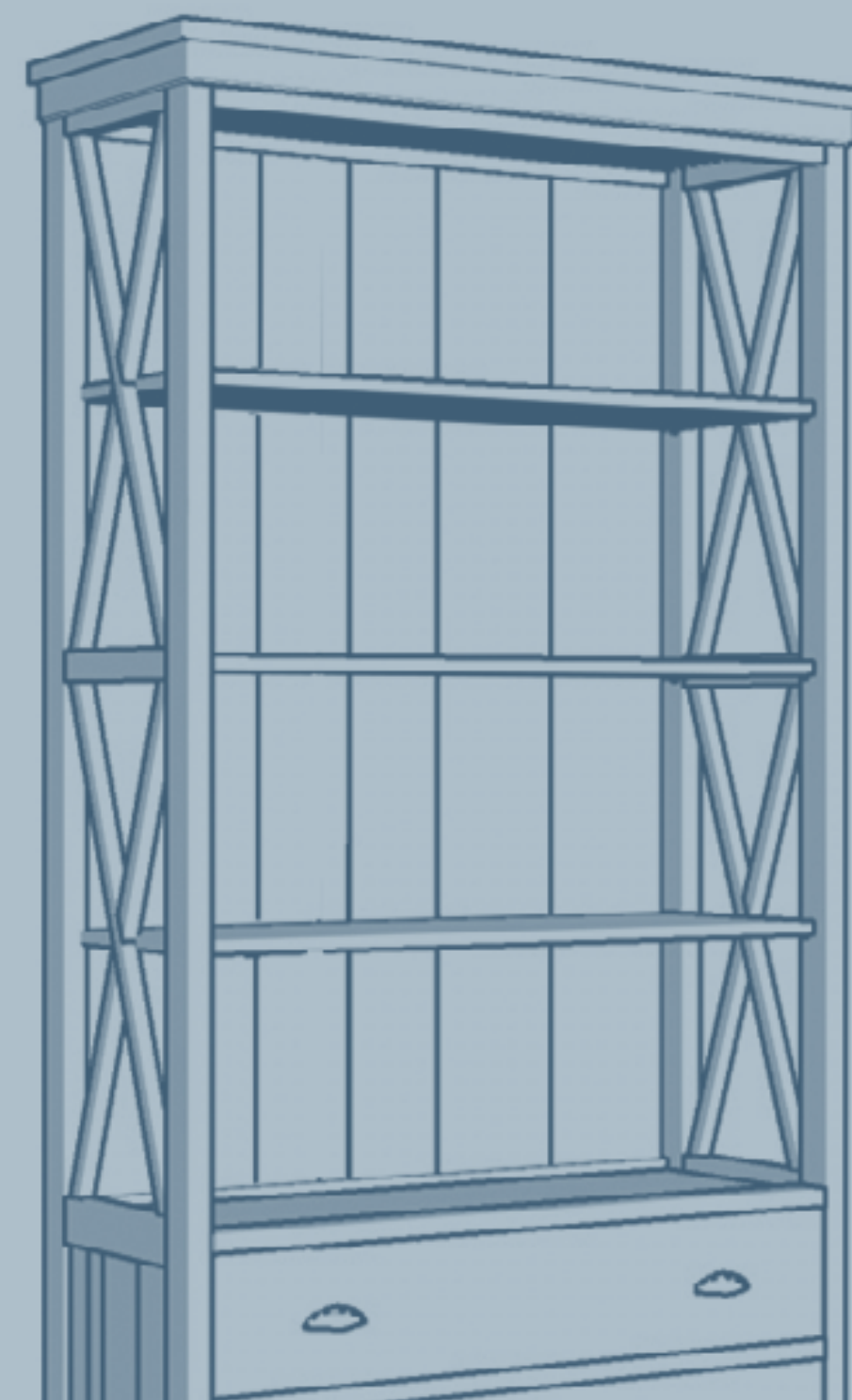

VERONA

**COLECCIÓN Verona**  
Collection Verona

Ref.

**Descripción**  
Description

**Medidas cm**  
Measure cm

**Puntos**  
Points

			A	B	C	A la Arena	
	<b>VC001</b>	Recibidor Verona Verona hall unit	60 x 200 x 24	<b>80</b>	<b>89</b>	<b>96</b>	<b>103</b>
			 0,165	 1 u			
	<b>VD015</b>	Espejo vestidor Verona Verona dresser mirror	60 x 143 x 2,5	<b>52</b>	<b>57</b>	<b>61</b>	<b>65</b>
			 0,026	 1 u			
	<b>VD017</b>	Baúl puertas Verona Cabinet Verona	100 x 53 x 36,5	<b>76</b>	<b>85</b>	<b>91</b>	<b>97</b>
			 0,202	 1 u			
	<b>VD016</b>	Perchero con estantes Verona Hanger with shelves Verona	70 x 55,5 x 25	<b>48</b>	<b>54</b>	<b>58</b>	<b>62</b>
			 0,103	 1 u			
	<b>VD011</b>	Zapatero Verona Verona shoe cabinet	66 x 106 x 40	<b>105</b>	<b>116</b>	<b>124</b>	<b>132</b>
			 0,314	 1 u			
	<b>VC002</b>	Aparador de 172 Verona Sideboard 172 Verona	172 x 98 x 43	<b>216</b>	<b>239</b>	<b>255</b>	<b>273</b>
			 0,771	 2 u			
	<b>VC003</b>	Aparador de 102 puertas cristal Verona Sideboard glass/drape doors 102 Verona	102 x 98 x 40	<b>156</b>	<b>173</b>	<b>184</b>	<b>197</b>
			 0,428	 1 u			



















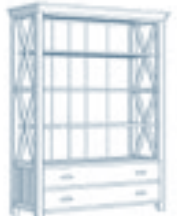

**COLECCIÓN Verona**  
Collection Verona

Ref.









**Descripción**  
Description

**Medidas cm**  
Measure cm

**Puntos**  
Points

			A	B	C	A la Arena	
	<b>VC004</b>	Aparador de 102 puertas madera Verona 2-Door sideboard 102 Verona	102 x 98 x 40	<b>156</b>	<b>173</b>	<b>184</b>	<b>197</b>
			 0,428	 1 u			
	<b>VC005</b>	Mesa T.V. de 180 Verona T.V. table 180 Verona	180 x 64 x 43	<b>144</b>	<b>160</b>	<b>171</b>	<b>183</b>
			 0,524	 1 u			
	<b>VC006</b>	Mesa T.V. de 140 Verona T.V. table 140 Verona	140 x 64 x 43	<b>113</b>	<b>125</b>	<b>134</b>	<b>143</b>
			 0,408	 1 u			
	<b>VC007</b>	Librero Verona de 105 Bookcase 105 Verona	105 x 200 x 40	<b>193</b>	<b>213</b>	<b>228</b>	<b>244</b>
			 0,822	 1 u			
	<b>VD014</b>	Librero Verona de 77 Bookcase 77 Verona	77 x 170 x 37	<b>119</b>	<b>132</b>	<b>141</b>	<b>151</b>
			 0,494	 1 u			
	<b>VC008</b>	Vitrina de 105 Verona Display case 105 Verona	105 x 200 x 40	<b>220</b>	<b>244</b>	<b>261</b>	<b>279</b>
			 0,820	 1 u			
	<b>VC009</b>	Vitrina baja de 85 Verona Low display 85 case Verona	85 x 128 x 40	<b>138</b>	<b>153</b>	<b>164</b>	<b>175</b>
			 0,449	 1 u			

**COLECCIÓN Verona**  
Collection Verona

Ref.	Descripción Description	Medidas cm Measure cm	Puntos Points			
			A	B	C	A la Arena
 <b>EC015</b>	<b>Juego de Buck de Piel</b> Set of leather drawers	Color: Marrón Color: Beige   0,044  1 u	26	26	26	26
 <b>VC010</b>	<b>Mesa de centro Verona</b> Coffee table Verona	110 x 45 x 60   0,272  1 u	72	80	86	92
 <b>VC011</b>	<b>Mesa terminal Verona</b> End table Verona	60 x 55 x 45   0,127  1 u	55	61	66	71

# COLECCIÓN BASILEA

## Collection BASILEA

COMEDORES  
DINNING ROOM 

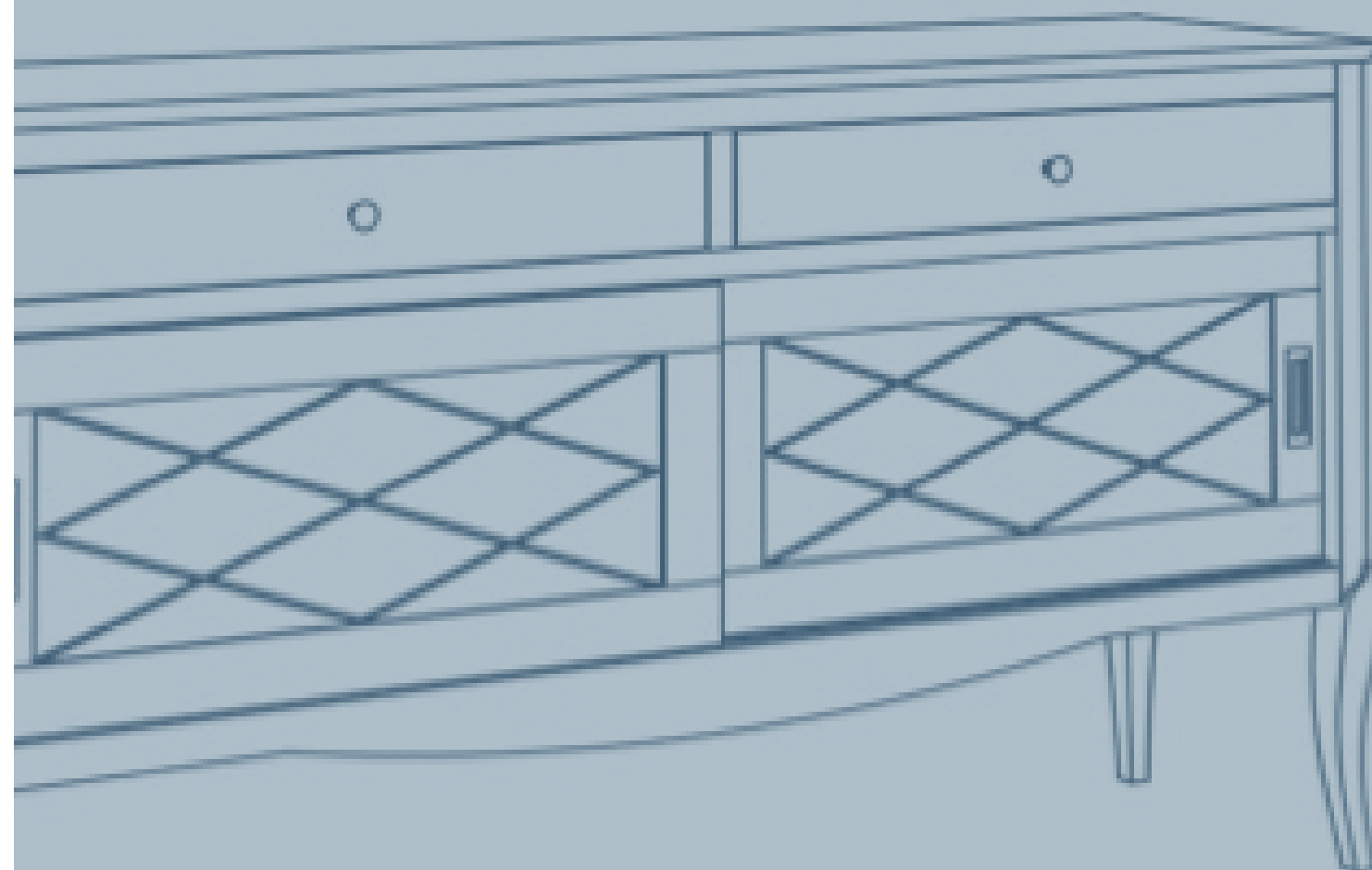

BASILEA







**COLECCIÓN Basilea**  
Collection Basilea

Ref.

Descripción  
Description

Medidas cm  
Measure cm

Puntos  
Points

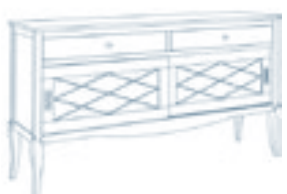
			A	B	C	A la Arena
	<b>BC001</b> Consola Basilea Console Basilea	94 x 77 x 30 0,216 1 u	65	72	77	82
	<b>BD014</b> Espejo de 94 x 86 Basilea Mirror 94 x 86 Basilea	94 x 86 x 6 0,058 1 u	61	68	72	77
	<b>BD015</b> Espejo de 94 x 86 sin celosía Basilea mirror 94 x 86, no latticework	94 x 86 x 6 0,058 1 u	46	51	55	59
	<b>BD016</b> Espejo de 94 x 134 Basilea Mirror 94 x 134 Basilea	94 x 134 x 6 0,090 1 u	75	83	89	95
	<b>BD017</b> Espejo de 66 x 63 Basilea Mirror 66 x 63 Basilea	66 x 63 x 6 0,027 1 u	55	57	61	65
	<b>BC002</b> Aparador de 180 con dos cajones y puertas madera- celosía Basilea Sideboard, 180 cm, with 2 drawers and Basilea wooden- latticework doors	180 x 100 x 47 0,868 1 u	224	248	265	284
	<b>BC003</b> Aparador de 180 con dos cajones y puertas madera Basilea Sideboard, 180 cm, with 2 drawers and Basilea wooden-doors	180 x 100 x 47 0,868 1 u	224	248	265	284





**COLECCIÓN Basilea**  
Collection Basilea

Ref.



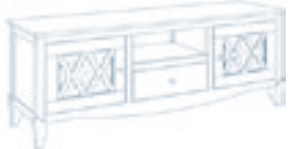
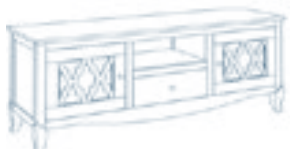
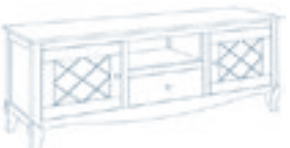



Descripción  
Description

Medidas cm  
Measure cm

Puntos  
Points

			A	B	C	A la Arena
	<b>BC004</b> Mesa T.V. de 165 puertas cristal-celosía Basilea 165-door glass-latticework TV table Basilea	165 x 65 x 47 0,516 1 u	175	194	207	221
	<b>BC005</b> Mesa T.V. de 165 puertas madera-celosía Basilea Table T.V. of 165 wood-lattice doors Basilea	165 x 65 x 47 0,516 1 u	175	194	207	221
	<b>BC006</b> Mesa T.V. de 165 puertas madera Basilea Table T.V. of 165 wood doors Basilea	165 x 65 x 47 0,516 1 u	175	194	207	221
	<b>BC007</b> Librero de 138 Basilea Bookcase 138 Basilea	138 x 210 x 42 1,328 2 u	266	294	314	336
	<b>BC008</b> Librero de 80 Basilea Bookcase 80 Basilea	80 x 200 x 42 0,682 1 u	187	207	221	236
	<b>BD013</b> Librero de 74 Basilea Bookcase 74 Basilea	74 x 125 x 39 0,363 1 u	120	129	142	152
	<b>BC009</b> Vitrina de 138 con puertas madera-celosía Basilea Showcase of 138 with wood- lattice doors Basilea	138 x 210 x 42 1,328 2 u	321	356	381	408

**COLECCIÓN Basilea**  
Collection Basilea

Ref.	Descripción Description	Medidas cm Measure cm	Puntos Points			
			A	B	C	A la Arena
 <b>BC010</b>	Vitrina de 138 con puertas madera Basilea <i>Showcase of 138 with wood doors Basilea</i>	138 x 210 x 42  1,328  2 u	<b>321</b>	<b>356</b>	<b>381</b>	<b>408</b>
 <b>BC011</b>	Vitrina baja de 108 con puertas madera-celosisia Basilea <i>Vitrina low of 108 with wood-lattice doors Basilea</i>	108 x 153 x 44  0,747  1 u	<b>144</b>	<b>160</b>	<b>171</b>	<b>183</b>
 <b>BC012</b>	Vitrina baja de 108 con puertas madera Basilea <i>Vitrina low of 108 with wood doors Basilea</i>	108 x 153 x 44  0,747  1 u	<b>144</b>	<b>160</b>	<b>171</b>	<b>183</b>
 <b>BC013</b>	Mesa de centro Basilea <i>Coffee table Basilea</i>	110 x 51 x 66  0,384  1 u	<b>101</b>	<b>112</b>	<b>120</b>	<b>128</b>
 <b>BC014</b>	Mesa terminal Basilea <i>End table Basilea</i>	55 x 55 x 42  0,133  1 u	<b>55</b>	<b>61</b>	<b>66</b>	<b>71</b>

# COLECCIÓN FONTANA

## Collection FONTANA

COMEDORES  
DINNING ROOM 





**COLECCIÓN Fontana**  
Collection Fontana

Ref.

**Descripción**  
Description

**Medidas cm**  
Measure cm

**Puntos**  
Points

			A	B	C	A la Arena
	<b>FC001</b> Conjunto recibidor Fontana <i>Hall set Fontana</i>	110 x 190 x 40 <small>0,553 2 u</small>	<b>200</b>	<b>219</b>	<b>234</b>	<b>250</b>
	<b>FC002</b> Percha puerta abatible Fontana <i>Folding door hanger Fontana</i>	64 x 170 x 22 <small>0,254 1 u</small>	<b>93</b>	<b>103</b>	<b>110</b>	<b>118</b>
	<b>FC003</b> Consola de 70 Fontana <i>Console 70 Fontana</i>	70 x 95 x 40 <small>0,276 1 u</small>	<b>117</b>	<b>128</b>	<b>136</b>	<b>146</b>
	<b>FC004</b> Espejo de 65 x 82 Fontana <i>Mirror 65 x 82 Fontana</i>	65 x 82 x 3 <small>0,022 1 u</small>	<b>34</b>	<b>38</b>	<b>40</b>	<b>43</b>
	<b>FC005</b> Aparador de 2 puertas Fontana <i>2-door sideboard Fontana</i>	120 x 105 x 45 <small>0,590 1 u</small>	<b>233</b>	<b>256</b>	<b>276</b>	<b>295</b>
	<b>FC006</b> Aparador de 4 puertas cristal Fontana <i>4-door glass sideboard Fontana</i>	120 x 105 x 45 <small>0,590 1 u</small>	<b>231</b>	<b>254</b>	<b>274</b>	<b>294</b>
	<b>FC007</b> Aparador de 4 puertas madera Fontana <i>4-door wood sideboard Fontana</i>	120 x 105 x 45 <small>0,590 1 u</small>	<b>231</b>	<b>254</b>	<b>274</b>	<b>294</b>



**COLECCIÓN Fontana**  
Collection Fontana

Ref.

**Descripción**  
Description

**Medidas cm**  
Measure cm

**Puntos**  
Points

			A	B	C	A la Arena
	<b>FC008</b> Aparador de 190 con puertas cristal Fontana <i>Door glass 190 sideboard Fontana</i>	190 x 105 x 45 <small>0,921 1 u</small>	<b>304</b>	<b>334</b>	<b>357</b>	<b>382</b>
	<b>FC009</b> Aparador de 190 con puertas madera Fontana <i>Door wood 190 sideboard Fontana</i>	190 x 105 x 45 <small>0,921 1 u</small>	<b>304</b>	<b>334</b>	<b>357</b>	<b>382</b>
	<b>FC010</b> Vajillero Fontana <i>Dish rack Fontana</i>	112 x 150 x 46 <small>0,796 1 u</small>	<b>249</b>	<b>273</b>	<b>292</b>	<b>312</b>
	<b>FC011</b> Mesa T.V. de 140 Fontana <i>T.V. table 140 Fontana</i>	140 x 65 x 45 <small>0,423 1 u</small>	<b>174</b>	<b>191</b>	<b>204</b>	<b>218</b>
	<b>FC012</b> Mesa T.V. de 120 Fontana <i>T.V. table 120 Fontana</i>	120 x 72 x 45 <small>0,406 1 u</small>	<b>205</b>	<b>224</b>	<b>239</b>	<b>256</b>
	<b>FC013</b> Mesa T.V. de 190 Fontana <i>T.V. table 190 Fontana</i>	190 x 61 x 45 <small>0,539 1 u</small>	<b>194</b>	<b>214</b>	<b>229</b>	<b>245</b>
	<b>FC014</b> Librero de 141 Fontana <i>Bookcase 141 Fontana</i>	141 x 203 x 40 <small>1,152 2 u</small>	<b>257</b>	<b>282</b>	<b>302</b>	<b>323</b>



**COLECCIÓN Fontana**  
Collection Fontana

Ref.

**Descripción**  
Description

**Medidas cm**  
Measure cm

**Puntos**  
Points

			A	B	C	A la Arena
	<b>FC015</b> Librero de 118 Fontana Bookcase 118 Fontana	118 x 200 x 40  0,961  1 u	<b>254</b>	<b>279</b>	<b>298</b>	<b>319</b>
	<b>FC016</b> Librero de 75 Fontana Bookcase 75 Fontana	75 x 200 x 40  0,626  1 u	<b>187</b>	<b>206</b>	<b>220</b>	<b>235</b>
	<b>FC017</b> Librero bajo con cajón Fontana Bookcase base with drawer Fontana	135 x 80 x 39  0,436  1 u	<b>125</b>	<b>137</b>	<b>146</b>	<b>156</b>
	<b>FC018</b> Librero de 130 Fontana Bookcase 130 Fontana	130 x 80 x 39  0,424  1 u	<b>154</b>	<b>169</b>	<b>181</b>	<b>194</b>
	<b>FC019</b> Vitrina de 75 Fontana derecha Showcase of 75 Fontana right	75 x 200 x 40  0,620  1 u	<b>201</b>	<b>220</b>	<b>235</b>	<b>251</b>
	<b>FC020</b> Vitrina de 75 Fontana izquierda Showcase of 75 Fontana left	75 x 200 x 40  0,620  1 u	<b>201</b>	<b>220</b>	<b>235</b>	<b>251</b>
	<b>FC021</b> Vitrina de 118 Fontana Showcase of 118 Fontana	118 x 200 x 40  0,974  1 u	<b>321</b>	<b>353</b>	<b>377</b>	<b>405</b>















**COLECCIÓN Fontana**  
Collection Fontana

Ref.

**Descripción**  
Description

**Medidas cm**  
Measure cm

**Puntos**  
Points

			A	B	C	A la Arena
	<b>FC022</b> Mesa de centro de 115 x 115 Fontana Fontana center table 115 x 115	115 x 45 x 115  0,619  1 u	<b>176</b>	<b>195</b>	<b>208</b>	<b>222</b>
	<b>FC023</b> Mesa de centro de 120 x 70 Fontana Fontana center table 120 x 70	120 x 45 x 70  0,395  1 u	<b>140</b>	<b>155</b>	<b>165</b>	<b>177</b>
	<b>FC024</b> Mesa terminal de 60 x 47 Fontana End table 60 x 47 Basilea	60 x 56 x 47  0,167  1 u	<b>55</b>	<b>60</b>	<b>64</b>	<b>68</b>
	<b>FC025</b> Mesa de rincón de 70 x 70 Fontana Corner table 70 x 70 Fontana	70 x 60 x 70  0,308  1 u	<b>70</b>	<b>77</b>	<b>83</b>	<b>89</b>
	<b>FC026</b> Bajo de cajones Fontana Fontana drawers	110 x 53 x 40  0,246  1 u	<b>94</b>	<b>104</b>	<b>111</b>	<b>119</b>



















# COLECCIÓN MEDITERRÁNEO

Collection **MEDITERRANEO**

COMEDORES  
DINNING ROOM











**COLECCIÓN**  
**Mediterráneo**  
*Collection Mediterraneo*

Ref.	Descripción <i>Description</i>	Medidas cm <i>Measure cm</i>	Puntos <i>Points</i>			
			A	B	C	A la Arena
 <b>MC001</b>	Consola Mediterráneo <i>Console Mediterraneo</i>	110 x 86 x 40  0,391   1 u	<b>111</b>	<b>121</b>	<b>130</b>	<b>139</b>
 <b>MD008</b>	Espejo Mediterráneo <i>Mirror Mediterraneo</i>	59 x 85 x 6  0,035   1 u	<b>61</b>	<b>67</b>	<b>72</b>	<b>77</b>
 <b>MD016</b>	Espejo vestidor Mediterráneo <i>Dressing mirror Mediterraneo</i>	67 x 134 x 6  0,060   1 u	<b>67</b>	<b>74</b>	<b>79</b>	<b>85</b>
 <b>MC002</b>	Aparador puertas cristal Mediterráneo <i>Sideboard glass doors Mediterraneo</i>	190 x 100 x 46  0,897   1 u	<b>302</b>	<b>332</b>	<b>355</b>	<b>380</b>
 <b>MC003</b>	Aparador puertas madera Mediterráneo <i>Sideboard wood doors Mediterraneo</i>	190 x 100 x 46  0,897   1 u	<b>302</b>	<b>332</b>	<b>355</b>	<b>380</b>
 <b>MC004</b>	Platero de 133 Mediterráneo <i>Plate cabinet 133 Mediterraneo</i>	133 x 210 x 45  1,282   2 u	<b>316</b>	<b>347</b>	<b>371</b>	<b>397</b>

**COLECCIÓN**  
**Mediterráneo**  
*Collection Mediterraneo*







Ref.	Descripción <i>Description</i>	Medidas cm <i>Measure cm</i>	Puntos <i>Points</i>			
			A	B	C	A la Arena
 <b>MC005</b>	Mesa T.V. de 210 Mediterráneo <i>T.V. table 210 Mediterraneo</i>	210 x 56 x 45  0,553   1 u	<b>182</b>	<b>200</b>	<b>214</b>	<b>229</b>
 <b>MC006</b>	Mesa T.V. de 150 Mediterráneo <i>T.V. table 150 Mediterraneo</i>	150 x 56 x 45  0,396   1 u	<b>146</b>	<b>160</b>	<b>171</b>	<b>183</b>
 <b>MC007</b>	Librero de 116 Mediterráneo <i>Bookcase 116 Mediterraneo</i>	116 x 200 x 47  1,129   1 u	<b>258</b>	<b>283</b>	<b>303</b>	<b>324</b>
 <b>MC008</b>	Librero de 120 Mediterráneo <i>Bookcase 120 Mediterraneo</i>	120 x 78 x 40  0,374   1 u	<b>144</b>	<b>158</b>	<b>169</b>	<b>181</b>
 <b>MC009</b>	Librero de 80 Mediterráneo <i>Bookcase 80 Mediterraneo</i>	80 x 130 x 45  0,483   1 u	<b>166</b>	<b>182</b>	<b>195</b>	<b>209</b>
 <b>MC010</b>	Vitrina de 116 Mediterráneo <i>Display case 116 Mediterraneo</i>	116 x 200 x 48  1,152   1 u	<b>277</b>	<b>305</b>	<b>326</b>	<b>349</b>

**COLECCIÓN**  
**Mediterráneo**  
*Collection Mediterraneo*

	Ref.	Descripción <i>Description</i>	Medidas cm <i>Measure cm</i>	Puntos <i>Points</i>			
				A	B	C	A la Arena
	<b>MC011</b>	Mesa de centro Mediterraneo <i>Coffee table Mediterraneo</i>	120 x 49 x 70  0,430  1 u	<b>94</b>	<b>103</b>	<b>111</b>	<b>118</b>
	<b>MC012</b>	Mesa terminal Mediterraneo <i>End table Mediterraneo</i>	60 x 56 x 45  0,160  1 u	<b>55</b>	<b>61</b>	<b>65</b>	<b>69</b>
	<b>MC013</b>	Bajo cajones Mediterraneo <i>Mediterraneo drawers</i>	129 x 57 x 45  0,343  1 u	<b>124</b>	<b>136</b>	<b>145</b>	<b>155</b>

**ASAS (distancia de taladro a taladro 64 mm)**

**HANDLES (drilling distance to drill 64 mm)**

					
Asa Fontana	Asa Mediterraneo	Asa Decco	Asa Verona	Asa Amberes	Asa Cerdeña

- Las asas podrán ser intercambiables entre las colecciones: Fontana, Mediterraneo, Decco, Verona, Amberes, Cerdeña y Nantes.
- El asa Mediterraneo sólo podrá ser utilizada en la serie Mediterraneo.
- Todas las asas serán metálicas con acabado oro envejecido y/o plata envejecida.
- Todos los pedidos deberán incluir el modelo y color de asa.

- *Handles or pulls are interchangeable among the following collections: Fontana, Mediterraneo, Decco, Verona, Amberes, Cerdeña and Nantes.*
- *The Mediterraneo handle can only be used with the Mediterraneo series.*
- *All handles are in metal with aged gold and/or aged silver finishes.*
- *All orders must include handle model and colour.*

**POMOS KNOBS**

						
Pomo ø 30mm metálico	Pomo ø 30mm madera	Pomo ø 45mm metálico	Pomo ø 45mm madera	Pomo bandejas	Pomo Decco	Pomo Fontana

- Los pomos podrán ser intercambiables entre las colecciones Fontana, Mediterraneo y Decco.
- En las bandejas sólo se podrá utilizar el "Pomo bandejas".
- Todos los pomos metálicos tendrán acabado oro viejo y/o plata vieja.
- Todos los pomos de madera se podrán tener cualquier acabado A, B, C o A LA ARENA.
- Todos los pedidos deberán incluir el modelo y color de pomo.

- *All knobs are interchangeable among the Fontana, Mediterraneo and Decco collections.*
- *For trays, only "Tray knobs" can be used.*
- *All metal knobs are in aged gold and/or aged silver finishes.*
- *All wood knobs may have any finish: A, B, C or SANDBLASTED.*
- *All orders must include knob model and colour.*

# COMPOSICIONES

## COMPOSITIONS

COMEDORES  
DINING ROOM

### COMP. 01C

	Ref.	UDS.	Descripción	Medidas	Puntos			
					A	B	C	A la Arena
	EL029	1	Costado izquierdo cristal de 240	36,5 x 240 x 4,7	29	32	35	37
	EL030	1	Costado derecho cristal de 240	36,5 x 240 x 4,7	29	32	35	37
	EL038	2	Costado central madera de 240 para puertas alta y baja	36,5 x 240 x 4,7	60	66	72	76
	EL040	3	Trasera módulo 2 puertas de 240	95 x 232 x 0,6	51	54	60	63
	EL045	3	Techo módulo 2 puertas para altura 200 y 240	36 x 93 x 5	51	54	60	63
	EL047	3	Divisor módulo 2 puertas para altura 240	34,3 x 93 x 1,9	45	51	54	60
	EL049	12	Estante módulo 2 puertas	30,3 x 93 x 1,9	180	192	216	228
	EL051	3	Base módulo 2 puertas	35 x 93 x 5	63	69	75	81
	EL052	6	Puerta alta cristal para altura de 160 y 240	46,2 x 149,7 x 2,5	90	102	108	120
	EL054	6	Puerta baja cristal para altura de 88 y 240	46,2 x 77,6 x 2,5	66	72	78	84
TOTAL PUNTOS					665	724	793	849

Blanco Decape/Kamel

### COMP. 01C

	Ref.	UDS.	Descripción	Medidas	Puntos				
					A	B	C	A la Arena	
	EL021	1	Costado izquierdo madera de 240	36,5 x 240 x 4,7	36	40	43	46	
	EL023	1	Costado derecho madera de 240	36,5 x 240 x 4,7	36	40	43	46	
	EL037	2	Costado central de 240	36,5 x 240 x 4,7	72	80	86	92	
	EL040	3	Trasera módulo 2 puertas de 240	95 x 232 x 0,6	51	54	60	63	
	EL045	3	Techo módulo 2 puertas para altura 200 y 240	36 x 93 x 5	51	54	60	63	
	EL047	3	Divisor módulo 2 puertas para altura 240	34,3 x 93 x 1,9	45	51	54	60	
	EL049	12	Estante módulo 2 puertas	30,3 x 93 x 1,9	180	192	216	228	
	EL051	3	Base módulo 2 puertas	35 x 93 x 5	63	69	75	81	
	TOTAL PUNTOS					535	580	637	679

Tabaco/Negro Humo  
Blanco Albo/Coral  
Blanco Decape/Kamel

### COMP. 01C

	Ref.	UDS.	Descripción	Medidas	Puntos			
					A	B	C	A la Arena
	EL033	1	Costado izquierdo madera de 240 para puerta baja	36,5 x 240 x 4,7	36	40	43	46
	EL036	1	Costado derecho madera de 240 para puerta baja	36,5 x 240 x 4,7	36	40	43	46
	EL039	1	Costado central madera de 240 para puerta baja	36,5 x 240 x 4,7	30	33	36	38
	EL040	2	Trasera módulo 2 puertas de 240	95 x 232 x 0,6	34	36	40	42
	EL045	2	Techo módulo 2 puertas para altura 200 y 240	36 x 93 x 5	34	36	40	42
	EL047	2	Divisor módulo 2 puertas para altura 240	34,3 x 93 x 1,9	30	34	36	40
	EL049	8	Estante módulo 2 puertas	30,3 x 93 x 1,9	120	128	144	152
	EL051	2	Base módulo 2 puertas	35 x 93 x 5	42	46	50	54
	EL055	4	Puerta baja madera para altura de 88 y 160	46,2 x 77,6 x 2,5	72	80	88	92
	TOTAL PUNTOS					435	473	520

Tabaco/Negro Humo  
Blanco Albo/Coral  
Blanco Decape/Kamel

### COMP. 01C

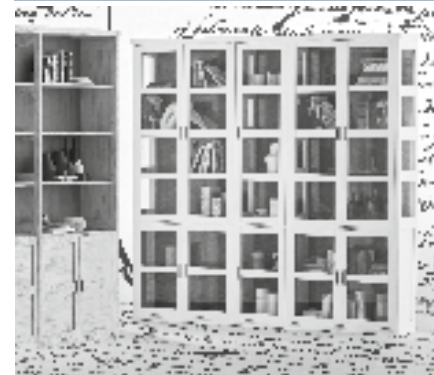
	Ref.	UDS.	Descripción	Medidas	Puntos			
					A	B	C	A la Arena
	EL029	1	Costado izquierdo cristal de 240	36,5 x 240 x 4,7	29	32	35	37
	EL030	1	Costado derecho cristal de 240	36,5 x 240 x 4,7	29	32	35	37
	EL038	2	Costado central madera de 240 para puertas alta y baja	36,5 x 240 x 4,7	60	66	72	76
	EL040	2	Trasera módulo 2 puertas de 240	95 x 232 x 0,6	34	36	40	42
	EL041	1	Trasera módulo 1 puerta de 240	48,6 x 232 x 0,6	9	10	11	12
	EL044	1	Techo módulo 1 puerta para altura 200 y 240	36 x 46 x 5	10	11	12	13
	EL045	2	Techo módulo 2 puertas para altura 200 y 240	36 x 93 x 5	34	36	40	42
	EL046	1	Divisor módulo 1 puerta para altura 240	34,3 x 46,6 x 1,9	9	10	11	12
	EL047	2	Divisor módulo 2 puertas para altura 240	34,3 x 93 x 1,9	30	34	36	40
	EL048	4	Estante módulo 1 puerta	30,3 x 46,6 x 1,9	32	36	40	44
	EL049	8	Estante módulo 2 puertas	30,3 x 93 x 1,9	120	128	144	152
	EL050	1	Base módulo 1 puerta	35 x 46,6 x 5	12	13	14	15
	EL051	2	Base módulo 2 puertas	35 x 93 x 5	42	46	50	54
	EL052	5	Puerta alta cristal para altura de 160 y 240	46,2 x 149,7 x 2,5	75	85	90	100
	EL054	5	Puerta baja cristal para altura de 88 y 160	46,2 x 77,6 x 2,5	55	60	65	70
TOTAL PUNTOS					580	635	695	747

Tabaco/Negro Humo  
Blanco Albo/Coral  
Blanco Decape/Kamel

### COMP. 02C



Blanco Albo/Gris Ceniza

Ref.	UDS.	Descripción	Medidas	Puntos			
				A	B	C	A la Arena
EL021	1	Costado izquierdo madera de 200	36,5 x 201 x 4,7	26	28	30	33
EL023	1	Costado derecho madera de 200	36,5 x 201 x 4,7	26	28	30	33
EL025	2	Costado central de 200	36,5 x 201 x 4,7	64	70	76	80
EL027	2	Trasera módulo 2 puertas de 200	95 x 192 x 0,6	28	32	34	36
EL028	1	Trasera módulo 1 puerta de 200	48,6 x 192 x 0,6	7	8	9	10
EL044	1	Techo módulo 1 puerta para altura 200 y 240	36 x 46 x 5	10	11	12	13
EL045	2	Techo módulo 2 puertas para altura 200 y 240	36 x 93 x 5	34	36	40	42
EL048	4	Estante módulo 1 puerta	30,3 x 46,6 x 1,9	32	36	40	44
EL049	8	Estante módulo 2 puertas	30,3 x 93 x 1,9	120	128	144	152
EL050	1	Base módulo 1 puerta	35 x 46,6 x 5	12	13	14	15
EL051	2	Base módulo 2 puertas	35 x 93 x 5	42	46	50	54
TOTAL PUNTOS				401	436	479	512

### COMP. 03C

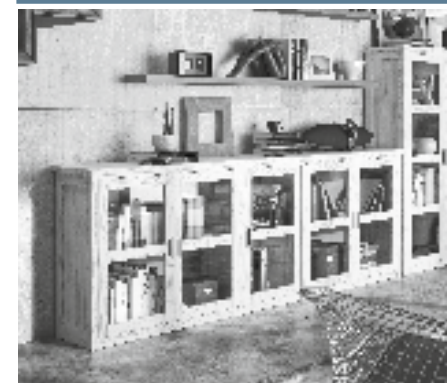

Blanco Albo/Turquesa

Ref.	UDS.	Descripción	Medidas	Puntos			
				A	B	C	A la Arena
EL002	1	Costado izquierdo madera de 88 para puertas	35 x 84,9 x 3,2	18	16	17	18
EL004	1	Costado derecho madera de 88 para puertas	35 x 84,9 x 3,2	14	16	17	18
EL006	2	Costado central madera de 88 para puertas	35 x 84,9 x 3,2	34	36	40	42
EL007	2	Trasera módulo 2 puertas de 88	95 x 80 x 0,6	12	14	16	18
EL008	1	Trasera módulo 1 puerta de 88	48,6 x 80 x 0,6	3	4	5	6
EL042	1	Techo módulo 1 puerta para altura 88 y 160	34,3 x 46,6 x 1,9	9	10	11	12
EL043	2	Techo módulo 2 puertas para altura 88 y 160	34,3 x 93 x 1,9	30	34	36	40
EL048	1	Estante módulo 1 puerta	30,3 x 46,6 x 1,9	8	9	10	11
EL049	2	Estante módulo 2 puertas	30,3 x 93 x 1,9	30	32	36	38
EL050	1	Base módulo 1 puerta	35 x 46,6 x 5	12	13	14	15
EL051	2	Base módulo 2 puertas	35 x 93 x 5	42	46	50	54
EL054	5	Puerta baja cristal para altura de 88 y 160	46,2 x 77,6 x 2,5	55	60	65	70
EL060	1	Tapa 1 módulo de 1 puerta y 2 de 2 puertas para altura 88 y 160	248 x 38 x 3	53	58	62	67
TOTAL PUNTOS				320	347	380	410

### COMP. 03C



Blanco Albo/Turquesa

Ref.	UDS.	Descripción	Medidas	Puntos			
				A	B	C	A la Arena
EL012	1	Costado izquierdo madera de 160 para puertas	35 x 157 x 3,2	24	26	28	30
EL014	1	Costado derecho madera de 160 para puertas	35 x 157 x 3,2	24	26	28	30
EL017	1	Trasera módulo 2 puertas de 160	95 x 152,1 x 0,6	12	13	14	15
EL043	1	Techo módulo 2 puertas para altura 88 y 160	34,3 x 93 x 1,9	15	17	18	20
EL049	3	Estante módulo 2 puertas	30,3 x 93 x 1,9	45	48	54	57
EL051	1	Base módulo 2 puertas	35 x 93 x 5	21	23	25	27
EL052	2	Puerta alta cristal para altura de 160 y 240	46,2 x 149,7 x 2,5	30	34	36	40
EL057	1	Tapa 1 módulo de 2 puertas para altura 88 y 160	105 x 39 x 3	19	20	22	24
TOTAL PUNTOS				189	208	226	242

### COMP. 04C



Blanco Pluma/Gris Ceniza

Ref.	UDS.	Descripción	Medidas	Puntos			
				A	B	C	A la Arena
EL011	1	Costado izquierdo madera de 160	35 x 157 x 3,2	24	26	28	30
EL013	1	Costado derecho madera de 160	35 x 157 x 3,2	24	26	28	30
EL015	2	Costado central de 160	35 x 157 x 3,2	30	34	36	40
EL017	3	Trasera módulo 2 puertas de 160	95 x 152,1 x 0,6	36	39	42	45
EL043	3	Techo módulo 2 puertas para altura 88 y 160	34,3 x 93 x 1,9	45	51	54	60
EL049	9	Estante módulo 2 puertas	30,3 x 93 x 1,9	135	144	162	171
EL051	3	Base módulo 2 puertas	35 x 93 x 5	63	69	75	81
EL061	1	Tapa 3 módulos de 2 puertas para altura de 88 y 160	295 x 38 x 3	62	68	73	79
TOTAL PUNTOS				418	457	499	536

### COMP. 04C



Blanco Pluma/Gris Ceniza

Ref.	UDS.	Descripción	Medidas	Puntos			
				A	B	C	A la Arena
EL002	1	Costado izquierdo madera de 88 para puertas	35 x 84,9 x 3,2	18	16	17	18
EL004	1	Costado derecho madera de 88 para puertas	35 x 84,9 x 3,2	14	16	17	18
EL006	1	Costado central madera de 88 para puertas	35 x 84,9 x 3,2	17	18	20	21
EL007	2	Trasera módulo 2 puertas de 88	95 x 80 x 0,6	12	14	16	18
EL043	2	Techo módulo 2 puertas para altura 88 y 160	34,3 x 93 x 1,9	30	34	36	40
EL049	2	Estante módulo 2 puertas	30,3 x 93 x 1,9	30	32	36	38
EL051	2	Base módulo 2 puertas	35 x 93 x 5	42	46	50	54
EL055	4	Puerta baja madera para altura de 88 y 160	46,2 x 77,6 x 2,5	72	80	88	92
EL059	1	Tapa 2 módulos de 2 puertas para altura de 88 y 160	198 x 38 x 3	33	37	40	43
TOTAL PUNTOS				269	293	320	343

### COMP. 05C

Ref.	UDS.	Descripción	Medidas	Puntos			
				A	B	C	A la Arena
295 x 160 x 38 (ABAJO)							
EL011	1	Costado izquierdo madera de 160	35 x 157 x 3,2	24	26	28	30
EL013	1	Costado derecho madera de 160	35 x 157 x 3,2	24	26	28	30
EL015	2	Costado central de 160	35 x 157 x 3,2	30	34	36	40
EL017	3	Trasera módulo 2 puertas de 160	95 x 152,1 x 0,6	36	39	42	45
EL043	3	Techo módulo 2 puertas para altura 88 y 160	34,3 x 93 x 1,9	45	51	54	60
EL049	9	Estante módulo 2 puertas	30,3 x 93 x 1,9	135	144	162	171
EL051	3	Base módulo 2 puertas	35 x 93 x 5	63	69	75	81
EL061	1	Tapa 3 módulos de 2 puertas para altura de 88 y 160	295 x 38 x 3	62	68	73	79
TOTAL PUNTOS				418	457	499	536

Tabaco/Negro Humo

### COMP. 05C

Ref.	UDS.	Descripción	Medidas	Puntos			
				A	B	C	A la Arena
295 x 240 x 36,5 (ARRIBA)							
EL031	1	Costado izquierdo madera de 240	36,5 x 240 x 4,7	29	32	35	37
EL034	1	Costado derecho madera de 240	36,5 x 240 x 4,7	29	32	35	37
EL037	2	Costado central de 240	36,5 x 240 x 4,7	72	80	86	92
EL040	3	Trasera módulo 2 puertas de 240	95 x 232 x 0,6	51	54	60	63
EL045	3	Techo módulo 2 puertas para altura 200 y 240	36 x 93 x 5	51	57	60	66
EL047	3	Divisor módulo 2 puertas para altura 240	34,3 x 93 x 1,9	45	51	54	60
EL049	12	Estante módulo 2 puertas	30,3 x 93 x 1,9	180	192	216	228
EL051	3	Base módulo 2 puertas	35 x 93 x 5	63	69	75	81
TOTAL PUNTOS				521	567	621	664

Tabaco/Negro Humo

### COMP. 07C

Ref.	UDS.	Descripción	Medidas	Puntos			
				A	B	C	A la Arena
391 x 240 x 36,5							
EL033	1	Costado izquierdo madera de 240 para puerta baja	36,5 x 240 x 4,7	36	40	43	46
EL036	1	Costado derecho madera de 240 para puerta baja	36,5 x 240 x 4,7	36	40	43	46
EL039	3	Costado central madera de 240 para puerta baja	36,5 x 240 x 4,7	30	33	36	38
EL040	4	Trasera módulo 2 puertas de 240	95 x 232 x 0,6	68	72	80	84
EL045	4	Techo módulo 2 puertas para altura 200 y 240	36 x 93 x 5	68	76	80	88
EL047	4	Divisor módulo 2 puertas para altura 240	34,3 x 93 x 1,9	60	68	72	80
EL049	16	Estante módulo 2 puertas	30,3 x 93 x 1,9	240	256	288	304
EL051	4	Base módulo 2 puertas	35 x 93 x 5	84	92	100	108
EL054	8	Puerta baja cristal para altura de 88 y 240	46,2 x 77,6 x 2,5	88	96	104	112
TOTAL PUNTOS				711	773	846	907

Blanco Decape

### COMP. 09C

Ref.	UDS.	Descripción	Medidas	Puntos			
				A	B	C	A la Arena
250 x 201 x 38							
EL022	1	Costado izquierdo madera de 200 para puertas	36,5 x 201 x 4,7	32	35	38	40
EL024	1	Costado derecho madera de 200 para puertas	36,5 x 201 x 4,7	32	35	38	40
EL026	2	Costado central de 200 para puertas	36,5 x 201 x 4,7	38	42	46	48
EL027	2	Trasera módulo 2 puertas de 200	95 x 192 x 0,6	28	32	34	36
EL028	1	Trasera módulo 1 puerta de 200	48,6 x 192 x 0,6	7	8	9	10
EL044	1	Techo módulo 1 puerta para altura 200 y 240	36 x 46 x 5	10	11	12	12
EL045	2	Techo módulo 2 puertas para altura 200 y 240	36 x 93 x 5	34	38	40	44
EL048	4	Estante módulo 1 puerta	30,3 x 46,6 x 1,9	32	36	40	44
EL049	8	Estante módulo 2 puertas	30,3 x 93 x 1,9	120	128	144	152
EL050	1	Base módulo 1 puerta	35 x 46,6 x 5	12	13	14	15
EL051	2	Base módulo 2 puertas	35 x 93 x 5	42	46	50	54
EL053	2	Puerta izquierda cristal para altura 200	46,2 x 190,7 x 2,5	54	58	62	68
EL062	3	Puerta derecha cristal para altura 200	46,2 x 190,7 x 2,5	81	87	93	102
TOTAL PUNTOS				522	569	619	666

Blanco Albo/Nogal Retorno

### COMP. 10C

Ref.	UDS.	Descripción	Medidas	Puntos			
				A	B	C	A la Arena
250 x 201 x 38							
EL022	1	Costado izquierdo madera de 200 para puertas	36,5 x 201 x 4,7	32	35	38	40
EL024	1	Costado derecho madera de 200 para puertas	36,5 x 201 x 4,7	32	35	38	40
EL026	2	Costado central de 200 para puertas	36,5 x 201 x 4,7	38	42	46	48
EL027	2	Trasera módulo 2 puertas de 200	95 x 192 x 0,6	28	32	34	36
EL028	1	Trasera módulo 1 puerta de 200	48,6 x 192 x 0,6	7	8	9	10
EL044	1	Techo módulo 1 puerta para altura 200 y 240	36 x 46 x 5	10	11	12	12
EL045	2	Techo módulo 2 puertas para altura 200 y 240	36 x 93 x 5	34	38	40	44
EL048	4	Estante módulo 1 puerta	30,3 x 46,6 x 1,9	32	36	40	44
EL049	8	Estante módulo 2 puertas	30,3 x 93 x 1,9	120	128	144	152
EL050	1	Base módulo 1 puerta	35 x 46,6 x 5	12	13	14	15
EL051	2	Base módulo 2 puertas	35 x 93 x 5	42	46	50	54
EL053	2	Puerta izquierda cristal para altura 200	46,2 x 190,7 x 2,5	54	58	62	68
EL062	3	Puerta derecha cristal para altura 200	46,2 x 190,7 x 2,5	81	87	93	102
TOTAL PUNTOS				522	569	619	666

Tosca/Azul Mar



## COMP. 14C



Blanco Pluma/Tabaco

Ref.	UDS.	Descripción	Medidas	Puntos			
				A	B	C	A la Arena
EL011	1	Costado izquierdo madera de 160	35 x 157 x 3,2	24	26	28	30
EL013	1	Costado derecho madera de 160	35 x 157 x 3,2	24	26	28	30
EL015	2	Costado central de 160	35 x 157 x 3,2	30	34	36	40
EL017	3	Trasera módulo 2 puertas de 160	95 x 152,1 x 0,6	36	39	42	45
EL043	3	Techo módulo 2 puertas para altura 88 y 160	34,3 x 93 x 1,9	15	18	21	24
EL049	9	Estante módulo 2 puertas	30,3 x 93 x 1,9	135	144	162	171
EL051	3	Base módulo 2 puertas	35 x 93 x 5	63	69	75	81
EL061	1	Tapa 3 módulos de 2 puertas para altura de 88 y 160	295 x 38 x 3	62	68	73	79
TOTAL PUNTOS				388	424	466	500

## COMP. 26C



Blanco Decape/Turquesa

Ref.	UDS.	Descripción	Medidas	Puntos			
				A	B	C	A la Arena
EL029	1	Costado izquierdo cristal de 240	36,5 x 240 x 4,7	29	32	35	37
EL030	1	Costado derecho cristal de 240	36,5 x 240 x 4,7	29	32	35	37
EL038	1	Costado central madera de 240 para puertas alta y baja	36,5 x 240 x 4,7	30	33	36	38
EL040	2	Trasera módulo 2 puertas de 240	95 x 232 x 0,6	34	36	40	42
EL045	2	Techo módulo 2 puertas para altura 200 y 240	36 x 93 x 5	34	38	40	44
EL047	2	Divisor módulo 2 puertas para altura 240	34,3 x 93 x 1,9	30	34	36	40
EL049	8	Estante módulo 2 puertas	30,3 x 93 x 1,9	120	128	144	152
EL051	2	Base módulo 2 puertas	35 x 93 x 5	42	46	50	54
EL052	4	Puerta alta cristal para altura de 160 y 240	46,2 x 149,7 x 2,5	60	68	72	80
EL054	4	Puerta baja cristal para altura de 88 y 240	46,2 x 77,6 x 2,5	44	48	52	56
TOTAL PUNTOS				453	496	540	581



GRUPO  
SEYS  
MUEBLES

# Un lugar de ensueño

Dormitorios,  
*Matrimonio*  
Bedroom



**TARIFA DE PRECIOS**  
*Bedrooms PRICE LIST*

GRUPO  
SEYS  
MUEBLES

Muebles GRUPO SEYS, S.A.

Ctra. Córdoba-Málaga, km. 76  
14900 - LUCENA (Córdoba)  
Tel. 957 50 26 97 - Fax 957 51 34 34  
nacional@gruposseys.com  
[www.gruposseys.com](http://www.gruposseys.com)

www.sistemas - 2018











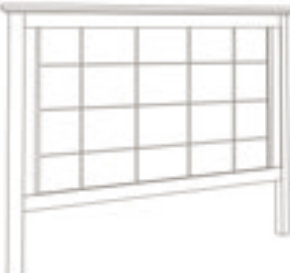

















# Cabeceros y Armarios

## Headboard and closets

DORMITORIOS  
BEDROOMS





















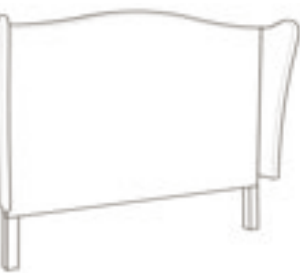



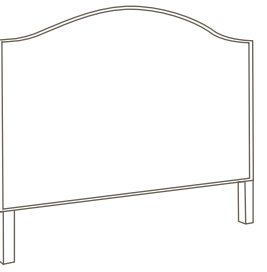

**Cabeceros**  
Headboard

Ref.	Descripción Description	Medidas cm Measure cm
	<b>CA003</b> Cabecero Cerdeña tapizado de 135 <i>Headboard Cerdeña 135</i>	153,5 x 145 x 9,5  0,216  1 u
	<b>CA004</b> Cabecero Cerdeña tapizado de 150 <i>Headboard Cerdeña 150</i>	168,5 x 145 x 9,5  0,237  1 u
	<b>CA005</b> Cabecero Cerdeña tapizado de 160 <i>Headboard Cerdeña 160</i>	178,5 x 145 x 9,5  0,251  1 u
	<b>CA006</b> Cabecero Cerdeña tapizado de 180 <i>Headboard Cerdeña 180</i>	198,5 x 145 x 9,5  0,279  1 u
	<b>CA007</b> Cabecero Lena de 90 <i>Headboard Lena 90</i>	100 x 136 x 7  0,090  1 u
	<b>CA008</b> Cabecero Lena de 105 <i>Headboard Lena 105</i>	115 x 136 x 7  0,104  1 u
	<b>CA009</b> Cabecero Lena de 135 <i>Headboard Lena 135</i>	145 x 151 x 7  0,145  1 u
	<b>CA010</b> Cabecero Lena de 150 <i>Headboard Lena 150</i>	160 x 151 x 7  0,160  1 u
	<b>CA011</b> Cabecero Lena de 160 <i>Headboard Lena 160</i>	170 x 151 x 7  0,170  1 u
	<b>CA012</b> Cabecero Lena de 180 <i>Headboard Lena 180</i>	190 x 151 x 7  0,190  1 u
	<b>CA013</b> Cabecero Indo de 90 <i>Headboard Indo 90</i>	111 x 137 x 4,5  0,070  1 u
	<b>CA014</b> Cabecero Indo de 105 <i>Headboard Indo 105</i>	126 x 137 x 5  0,079  1 u

**Tapizados**  
Upholstery

		Puntos / Points											
		A			B			C			A la arena		
T/cliente		2	3	T/cliente	2	3	T/cliente	2	3	T/cliente	2	3	
95		100	105	104	110	116	113	119	125	121	127	134	
98		103	108	107	113	119	116	122	128	124	131	137	
104		111	118	115	122	130	124	132	140	132	141	150	
107		114	121	118	125	133	127	135	144	136	145	154	
68		72	76	68	72	76	68	72	76	68	72	76	
71		74	78	71	74	78	71	74	78	71	74	78	
88		94	99	88	94	99	88	94	99	88	94	99	
95		101	107	95	101	107	95	101	107	95	101	107	
97		104	111	97	104	111	97	104	111	97	104	111	
102		110	118	102	110	118	102	110	118	102	110	118	
84		89	93	84	89	93	84	89	93	84	89	93	
86		92	97	86	92	97	86	92	97	86	92	97	

**Cabeceros**  
Headboard

Ref.	Descripción Description	Medidas cm Measure cm
	<b>CA015</b> Cabecero Indo de 135 Headboard Indo 135	159 x 150 x 5  0,109  1 u
	<b>CA016</b> Cabecero Indo de 150 Headboard Indo 150	174 x 150 x 5  0,120  1 u
	<b>CA017</b> Cabecero Indo de 160 Headboard Indo 160	184 x 150 x 4,5  0,127  1 u
	<b>CA018</b> Cabecero Indo de 180 Headboard Indo 180	204 x 150 x 5  0,140  1 u
	<b>CA019</b> Cabecero Sella de 135 Headboard Sella 135	168 x 153 x 31  0,813  1 u
	<b>CA020</b> Cabecero Sella de 150 Headboard Sella 150	183 x 153 x 31  0,885  1 u
	<b>CA021</b> Cabecero Sella de 160 Headboard Sella 160	193 x 153 x 31  0,934  1 u
	<b>CA022</b> Cabecero Sella de 180 Headboard Sella 180	213 x 153 x 31  1,030  1 u
	<b>CA023</b> Cabecero Bristol de 135 Headboard Bristol 135	145 x 136 x 6,5  0,122  1 u
	<b>CA024</b> Cabecero Bristol de 150 Headboard Bristol 150	160 x 136 x 6,5  0,135  1 u
	<b>CA025</b> Cabecero Bristol de 160 Headboard Bristol 160	170 x 136 x 6,5  0,143  1 u
	<b>CA026</b> Cabecero Bristol de 180 Headboard Bristol 180	190 x 136 x 6,5  0,160  1 u

**Tapizados**  
Upholstery

		Puntos / Points											
		A			B			C			A la arena		
T/cliente		2	3	T/cliente	2	3	T/cliente	2	3	T/cliente	2	3	
98		104	111	98	104	111	98	104	111	98	104	111	
99		106	114	99	106	114	99	106	114	99	106	114	
103		111	118	103	111	118	103	111	118	103	111	118	
105		113	121	105	113	121	105	113	121	105	113	121	
126		138	149	126	138	149	126	138	149	126	138	149	
128		140	151	128	140	151	128	140	151	128	140	151	
130		143	155	130	143	155	130	143	155	130	143	155	
133		146	159	133	146	159	133	146	159	133	146	159	
86		92	97	86	92	97	86	92	97	86	92	97	
93		99	106	93	99	106	93	99	106	93	99	106	
98		105	112	98	105	112	98	105	112	98	105	112	
108		115	124	108	115	124	108	115	124	108	115	124	

## Cabeceros Headboard

### Telas disponibles para grupo 2 Fabrics available for Group 2

**FROCA**

<b>Besora</b>	<b>Lido</b>
<b>Blanes</b>	<b>Mirasol</b>
<b>Bombone</b>	<b>Olot</b>
<b>Brando</b>	<b>Torrent</b>
<b>Brunei</b>	<b>Tortosa</b>
<b>Fonteta</b>	<b>Vinaros</b>
<b>Habana</b>	

### Telas disponibles para grupo 3 Fabrics available for Group 3

**FROCA**

<b>Arturo</b>	<b>Lancelot</b>	<b>Rayong</b>
<b>Bangkok</b>	<b>London</b>	<b>Samvi</b>
<b>Bari</b>	<b>Mitchel</b>	<b>Savona</b>
<b>Como</b>	<b>Moscu</b>	<b>Sofía</b>
<b>Crakovia</b>	<b>Oslo</b>	<b>Viena</b>
<b>Dortmund</b>	<b>Pianord</b>	<b>Voluta</b>
<b>Glasgow</b>	<b>Pisa</b>	
<b>Kiev</b>	<b>Praga</b>	

**RUSTIKA®**

<b>Libro Adra</b>	<b>Libro Lugano</b>
<b>Libro Aitana</b>	<b>Libro Marina</b>
<b>Libro Aneto</b>	<b>Libro Merida</b>
<b>Libro Carabu-HP</b>	<b>Libro Novara</b>
<b>Libro Eden</b>	<b>Libro Solara</b>
<b>Libro Evora</b>	<b>Libro Vera</b>
<b>Libro Himalaya</b>	

**visual®**  
OOO TEXTURES

<b>Libro Bellagio</b>	<b>Libro Mika</b>	<b>Libro Romantic</b>
<b>Libro Capriccio</b>	<b>Libro Minerva</b>	<b>Libro Samira</b>
<b>Libro Fantasy</b>	<b>Libro Moon</b>	<b>Libro Vivalto</b>
<b>Libro Harika</b>	<b>Libro Mystic</b>	
<b>Libro Invictus</b>	<b>Libro Nanao</b>	
<b>Libro Keops</b>	<b>Libro Naomi</b>	
<b>Libro Matsue</b>	<b>Libro Otaru</b>	























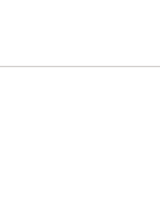







## Ref. Descripción Metraje m Description Measure cm

<b>CA003</b>	Cabecero Cerdeña de 135 / <i>Headboard Cerdeña 135</i>	1,5
<b>CA004</b>	Cabecero Cerdeña de 150 / <i>Headboard Cerdeña 150</i>	1,5
<b>CA005</b>	Cabecero Cerdeña de 160 / <i>Headboard Cerdeña 160</i>	2
<b>CA006</b>	Cabecero Cerdeña de 180 / <i>Headboard Cerdeña 180</i>	2
<b>CA007</b>	Cabecero Lena de 90 / <i>Headboard Lena 90</i>	1,1
<b>CA008</b>	Cabecero Lena de 105 / <i>Headboard Lena 105</i>	1,2
<b>CA009</b>	Cabecero Lena de 135 / <i>Headboard Lena 135</i>	1,5
<b>CA010</b>	Cabecero Lena de 150 / <i>Headboard Lena 150</i>	1,7
<b>CA011</b>	Cabecero Lena de 160 / <i>Headboard Lena 160</i>	1,8
<b>CA012</b>	Cabecero Lena de 180 / <i>Headboard Lena 180</i>	2
<b>CA013</b>	Cabecero Indo de 90 / <i>Headboard Indo 90</i>	1,2
<b>CA014</b>	Cabecero Indo de 105 / <i>Headboard Indo 105</i>	1,4
<b>CA015</b>	Cabecero Indo de 135 / <i>Headboard Indo 135</i>	1,7
<b>CA016</b>	Cabecero Indo de 150 / <i>Headboard Indo 150</i>	1,8
<b>CA017</b>	Cabecero Indo de 160 / <i>Headboard Indo 160</i>	1,9
<b>CA018</b>	Cabecero Indo de 180 / <i>Headboard Indo 180</i>	2,1
<b>CA019</b>	Cabecero Sella de 135 / <i>Headboard Sella 135</i>	3,1
<b>CA020</b>	Cabecero Sella de 150 / <i>Headboard Sella 150</i>	3,3
<b>CA021</b>	Cabecero Sella de 160 / <i>Headboard Sella 160</i>	3,5
<b>CA022</b>	Cabecero Sella de 180 / <i>Headboard Sella 180</i>	3,6
<b>CA023</b>	Cabecero Bristol de 135 / <i>Headboard Bristol 135</i>	1,6
<b>CA024</b>	Cabecero Bristol de 150 / <i>Headboard Bristol 150</i>	1,8
<b>CA025</b>	Cabecero Bristol de 160 / <i>Headboard Bristol 160</i>	1,9
<b>CA026</b>	Cabecero Bristol de 180 / <i>Headboard Bristol 180</i>	2,1
<b>BB001</b>	Banqueta con cajón Basilea / <i>Bench with drawer Basilea</i>	0,7
<b>BB002</b>	Banqueta Basilea / <i>Bench Basilea</i>	0,7
<b>BB003</b>	Banqueta Fontana / <i>Bench Fontana</i>	0,7
<b>BB004</b>	Banqueta Mediterráneo / <i>Bench Mediterraneo</i>	0,7
<b>BB005</b>	Butaca Colette / <i>Headboard Colette</i>	2,5
<b>BB006</b>	Butaca Diana / <i>Headboard Diana</i>	2,5























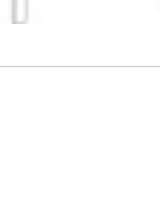





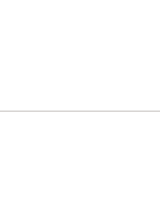

\* NOTA: Estos metrajes son generales, tener en cuenta un sobredimensionamiento de éstos en el caso de que se quiera centrar algún dibujo contenido en la tela.

\* NOTE: This per-metre information is general. Please remember that centring patterns on furniture may require more metres than otherwise.

**Cabeceros madera**  
*Wood Headboard*





























Ref.	Descripción <i>Description</i>	Medidas cm <i>Measure cm</i>	Puntos <i>Points</i>			
			A	B	C	A la Arena
	<b>CA001</b> Cabecero Cerdeña de 90 <i>Headboard Cerdeña 90</i>	108,5 X 135 X 9,5	<b>55</b>	<b>61</b>	<b>66</b>	<b>70</b>
		 0,152  1 u				
	<b>CA002</b> Cabecero Cerdeña de 105 <i>Headboard Cerdeña 105</i>	123,5 X 135 X 9,5	<b>60</b>	<b>65</b>	<b>71</b>	<b>76</b>
		 0,174  1 u				
	<b>CA027</b> Cabecero Volga de 90 <i>Headboard Volga 90</i>	100 x 156 x 5,5	<b>70</b>	<b>77</b>	<b>83</b>	<b>89</b>
		 0,085  1 u				
	<b>CA028</b> Cabecero Volga de 105 <i>Headboard Volga 105</i>	115 x 156 x 5,5	<b>76</b>	<b>84</b>	<b>90</b>	<b>96</b>
		 0,098  1 u				
	<b>CA029</b> Cabecero Volga de 135 <i>Headboard Volga 135</i>	145 x 156,5 x 6	<b>93</b>	<b>103</b>	<b>110</b>	<b>118</b>
		 0,134  1 u				
	<b>CA030</b> Cabecero Volga de 150 <i>Headboard Volga 150</i>	160 x 156,5 x 6	<b>102</b>	<b>113</b>	<b>121</b>	<b>129</b>
		 0,148  1 u				
	<b>CA031</b> Cabecero Volga de 160 <i>Headboard Volga 160</i>	170 x 156,5 x 6	<b>107</b>	<b>119</b>	<b>127</b>	<b>136</b>
		 0,157  1 u				
	<b>CA032</b> Cabecero Volga de 180 <i>Headboard Volga 180</i>	190 x 156,5 x 6	<b>119</b>	<b>132</b>	<b>141</b>	<b>151</b>
		 0,175  1 u				
	<b>CA033</b> Cama con dosel Volga 135 <i>Canopy bed Volga 135</i>	145,5 x 210 x 207	<b>284</b>	<b>315</b>	<b>337</b>	<b>361</b>
		 0,355  3 u				
	<b>CA034</b> Cama con dosel Volga 150 <i>Canopy bed Volga 150</i>	160,5 x 210 x 207	<b>305</b>	<b>338</b>	<b>362</b>	<b>387</b>
		 0,380  3 u				
	<b>CA035</b> Cama con dosel Volga 160 <i>Canopy bed Volga 160</i>	170,5 x 210 x 207	<b>315</b>	<b>350</b>	<b>375</b>	<b>401</b>
		 0,397  3 u				
	<b>CA036</b> Cama con dosel Volga 180 <i>Canopy bed Volga 180</i>	190,5 x 210 x 207	<b>335</b>	<b>372</b>	<b>398</b>	<b>426</b>
		 0,431  3 u				

**Cabeceros madera**  
*Wood Headboard*





























Ref.	Descripción <i>Description</i>	Medidas cm <i>Measure cm</i>	Puntos <i>Points</i>			
			A	B	C	A la Arena
	<b>CA037</b> Cabecero Verona de 90 <i>Headboard Verona 90</i>	99 x 126 x 3,3	<b>41</b>	<b>46</b>	<b>49</b>	<b>52</b>
		 0,050  1 u				
	<b>CA038</b> Cabecero Verona de 105 <i>Headboard Verona 105</i>	114 x 126 x 3,3	<b>45</b>	<b>50</b>	<b>53</b>	<b>57</b>
		 0,058  1 u				
	<b>CA039</b> Cabecero Verona de 135 <i>Headboard Verona 135</i>	144 x 126 x 3,5	<b>53</b>	<b>58</b>	<b>62</b>	<b>66</b>
		 0,073  1 u				
	<b>CA040</b> Cabecero Verona de 150 <i>Headboard Verona 150</i>	159 x 126 x 3,5	<b>57</b>	<b>63</b>	<b>67</b>	<b>72</b>
		 0,081  1 u				
	<b>CA041</b> Cabecero Verona de 160 <i>Headboard Verona 160</i>	169 x 126 x 3,5	<b>60</b>	<b>66</b>	<b>71</b>	<b>76</b>
		 0,086  1 u				
	<b>CA042</b> Cabecero Verona de 180 <i>Headboard Verona 180</i>	189 x 126 x 3,5	<b>66</b>	<b>74</b>	<b>79</b>	<b>85</b>
		 0,101  1 u				
	<b>CA043</b> Cabecero Basilea de 90 <i>Headboard Basilea 90</i>	108,5 x 123 x 6	<b>53</b>	<b>59</b>	<b>63</b>	<b>67</b>
		 0,093  1 u				
	<b>CA044</b> Cabecero Basilea de 105 <i>Headboard Basilea 105</i>	123,5 x 123 x 6	<b>59</b>	<b>65</b>	<b>70</b>	<b>75</b>
		 0,108  1 u				
	<b>CA045</b> Cabecero Basilea de 135 <i>Headboard Basilea 135</i>	153,5 x 123 x 6	<b>69</b>	<b>74</b>	<b>82</b>	<b>88</b>
		 0,124  1 u				
	<b>CA046</b> Cabecero Basilea de 150 <i>Headboard Basilea 150</i>	168,5 x 123 x 6	<b>73</b>	<b>79</b>	<b>87</b>	<b>93</b>
		 0,136  1 u				
	<b>CA047</b> Cabecero Basilea de 160 <i>Headboard Basilea 160</i>	178,5 x 123 x 6	<b>79</b>	<b>88</b>	<b>94</b>	<b>101</b>
		 0,144  1 u				
	<b>CA048</b> Cabecero Basilea de 180 <i>Headboard Basilea 180</i>	198,5 x 123 x 6	<b>86</b>	<b>95</b>	<b>102</b>	<b>109</b>
		 0,160  1 u				















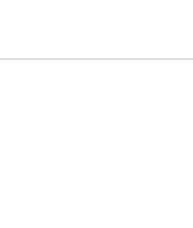





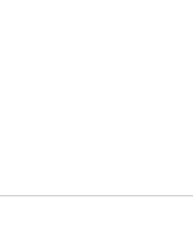





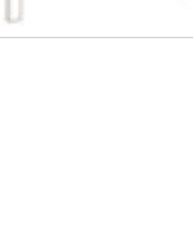







**Cabeceros madera**  
*Wood Headboard*

Ref.	Descripción <i>Description</i>	Medidas cm <i>Measure cm</i>	Puntos <i>Points</i>			
			A	B	C	A la Arena
	<b>CA049</b> Cabecero Fontana de 90 <i>Headboard Fontana 90</i>	107 x 125 x 7,5  0,100  1 u	<b>47</b>	<b>52</b>	<b>55</b>	<b>59</b>
	<b>CA050</b> Cabecero Fontana de 105 <i>Headboard Fontana 105</i>	122 x 125 x 7,5  0,114  1 u	<b>56</b>	<b>62</b>	<b>67</b>	<b>72</b>
	<b>CA051</b> Cabecero Fontana de 135 <i>Headboard Fontana 135</i>	152 x 125 x 7,5  0,142  1 u	<b>71</b>	<b>78</b>	<b>84</b>	<b>90</b>
	<b>CA052</b> Cabecero Fontana de 150 <i>Headboard Fontana 150</i>	167 x 125 x 7,5  0,156  1 u	<b>79</b>	<b>87</b>	<b>93</b>	<b>100</b>
	<b>CA053</b> Cabecero Fontana de 160 <i>Headboard Fontana 160</i>	177 x 125 x 7,5  0,175  1 u	<b>86</b>	<b>96</b>	<b>102</b>	<b>109</b>
	<b>CA054</b> Cabecero Fontana de 180 <i>Headboard Fontana 180</i>	197 x 125 x 7,5  0,183  1 u	<b>96</b>	<b>107</b>	<b>114</b>	<b>122</b>
	<b>CA055</b> Cabecero Mediterráneo de 90 <i>Headboard Mediterraneo 90</i>	105 x 120 x 8  0,109  1 u	<b>65</b>	<b>72</b>	<b>77</b>	<b>82</b>
	<b>CA056</b> Cabecero Mediterráneo de 105 <i>Headboard Mediterraneo 105</i>	120 x 120 x 8  0,124  1 u	<b>71</b>	<b>78</b>	<b>83</b>	<b>89</b>
	<b>CA057</b> Cabecero Mediterráneo de 135 <i>Headboard Mediterraneo 135</i>	150 x 120 x 8  0,155  1 u	<b>93</b>	<b>103</b>	<b>110</b>	<b>118</b>
	<b>CA058</b> Cabecero Mediterráneo de 150 <i>Headboard Mediterraneo 150</i>	165 x 120 x 8  0,171  1 u	<b>98</b>	<b>108</b>	<b>115</b>	<b>123</b>
	<b>CA059</b> Cabecero Mediterráneo de 160 <i>Headboard Mediterraneo 160</i>	175 x 120 x 8  0,181  1 u	<b>103</b>	<b>114</b>	<b>122</b>	<b>131</b>
	<b>CA060</b> Cabecero Mediterráneo de 180 <i>Headboard Mediterraneo 180</i>	195 x 120 x 8  0,201  1 u	<b>110</b>	<b>122</b>	<b>131</b>	<b>140</b>













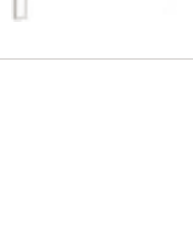





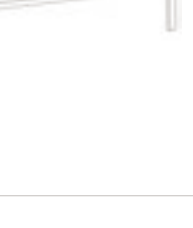





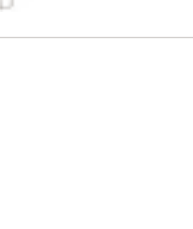







**Cabeceros madera**  
*Wood Headboard*

Ref.	Descripción <i>Description</i>	Medidas cm <i>Measure cm</i>	Puntos <i>Points</i>			
			A	B	C	A la Arena
	<b>CA061</b> Cabecero Mediterráneo liso de 90 <i>Headboard Mediterraneo 90</i>	105 x 120 x 8  0,109  1 u	<b>58</b>	<b>65</b>	<b>70</b>	<b>75</b>
	<b>CA062</b> Cabecero Mediterráneo liso de 105 <i>Headboard Mediterraneo 105</i>	120 x 120 x 8  0,124  1 u	<b>63</b>	<b>70</b>	<b>75</b>	<b>80</b>
	<b>CA063</b> Cabecero Mediterráneo liso de 135 <i>Headboard Mediterraneo 135</i>	150 x 120 x 8  0,155  1 u	<b>83</b>	<b>93</b>	<b>100</b>	<b>107</b>
	<b>CA064</b> Cabecero Mediterráneo liso de 150 <i>Headboard Mediterraneo 150</i>	165 x 120 x 8  0,171  1 u	<b>87</b>	<b>97</b>	<b>104</b>	<b>111</b>
	<b>CA065</b> Cabecero Mediterráneo liso de 160 <i>Headboard Mediterraneo 160</i>	175 x 120 x 8  0,181  1 u	<b>95</b>	<b>105</b>	<b>113</b>	<b>121</b>
	<b>CA066</b> Cabecero Mediterráneo liso de 180 <i>Headboard Mediterraneo 180</i>	195 x 120 x 8  0,201  1 u	<b>106</b>	<b>117</b>	<b>125</b>	<b>134</b>
	<b>CA067</b> Cabecero Decco de 90 <i>Headboard Decco 90</i>	98 x 124,5 x 4,5  0,068  1 u	<b>61</b>	<b>68</b>	<b>73</b>	<b>78</b>
	<b>CA068</b> Cabecero Decco de 105 <i>Headboard Decco 105</i>	113 x 124,5 x 4,5  0,078  1 u	<b>69</b>	<b>77</b>	<b>82</b>	<b>88</b>
	<b>CA069</b> Cabecero Decco de 135 <i>Headboard Decco 135</i>	143 x 124,5 x 4,5  0,099  1 u	<b>78</b>	<b>87</b>	<b>93</b>	<b>100</b>
	<b>CA070</b> Cabecero Decco de 150 <i>Headboard Decco 150</i>	158 x 124,5 x 4,5  0,109  1 u	<b>86</b>	<b>96</b>	<b>103</b>	<b>110</b>
	<b>CA071</b> Cabecero Decco de 160 <i>Headboard Decco 160</i>	168 x 124,5 x 4,5  0,105  1 u	<b>94</b>	<b>104</b>	<b>111</b>	<b>119</b>
	<b>CA072</b> Cabecero Decco de 180 <i>Headboard Decco 180</i>	188 x 124,5 x 4,5  0,118  1 u	<b>111</b>	<b>123</b>	<b>132</b>	<b>141</b>





























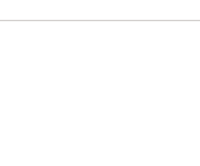

**Cabeceros madera**  
*Wood Headboard*

Ref.	Descripción <i>Description</i>	Medidas cm <i>Measure cm</i>	Puntos <i>Points</i>			
			A	B	C	A la Arena
	<b>CA073</b> Cabecero Mistral de 90 <i>Headboard Mistral 90</i>	107 x 125 x 7,5  0,100  1 u	<b>65</b>	<b>72</b>	<b>77</b>	<b>82</b>
	<b>CA074</b> Cabecero Mistral de 105 <i>Headboard Mistral 105</i>	122 x 125 x 7,5  0,114  1 u	<b>71</b>	<b>78</b>	<b>83</b>	<b>89</b>
	<b>CA075</b> Cabecero Mistral de 135 <i>Headboard Mistral 135</i>	152 x 125 x 7,5  0,142  1 u	<b>93</b>	<b>103</b>	<b>110</b>	<b>118</b>
	<b>CA076</b> Cabecero Mistral de 150 <i>Headboard Mistral 150</i>	167 x 125 x 7,5  0,155  1 u	<b>98</b>	<b>108</b>	<b>115</b>	<b>123</b>
	<b>CA077</b> Cabecero Mistral de 160 <i>Headboard Mistral 160</i>	177 x 125 x 7,5  0,165  1 u	<b>103</b>	<b>114</b>	<b>122</b>	<b>131</b>
	<b>CA078</b> Cabecero Mistral de 180 <i>Headboard Mistral 180</i>	197 x 125 x 7,5  0,183  1 u	<b>109</b>	<b>121</b>	<b>130</b>	<b>139</b>
	<b>CA079</b> Cabecero Besora de 90 <i>Headboard Besora 90</i>	98,5 x 120 x 5,5  0,066  1 u	<b>43</b>	<b>48</b>	<b>51</b>	<b>55</b>
	<b>CA080</b> Cabecero Besora de 105 <i>Headboard Besora 105</i>	113,5 x 120 x 5,5  0,076  1 u	<b>50</b>	<b>55</b>	<b>60</b>	<b>64</b>
	<b>CA081</b> Cabecero Besora de 135 <i>Headboard Besora 135</i>	143,5 x 120 x 5,5  0,096  1 u	<b>65</b>	<b>72</b>	<b>77</b>	<b>82</b>
	<b>CA082</b> Cabecero Besora de 150 <i>Headboard Besora 150</i>	158,5 x 120 x 5,5  0,106  1 u	<b>69</b>	<b>76</b>	<b>81</b>	<b>87</b>
	<b>CA083</b> Cabecero Besora de 160 <i>Headboard Besora 160</i>	168,5 x 120 x 5,5  0,113  1 u	<b>75</b>	<b>84</b>	<b>89</b>	<b>95</b>
	<b>CA084</b> Cabecero Besora de 180 <i>Headboard Besora 180</i>	188,5 x 120 x 5,5  0,126  1 u	<b>83</b>	<b>92</b>	<b>99</b>	<b>106</b>































**Cabeceros madera**  
*Wood Headboard*

Ref.	Descripción <i>Description</i>	Medidas cm <i>Measure cm</i>	Puntos <i>Points</i>			
			A	B	C	A la Arena
	<b>CA085</b> Cabecero Nilo de 90 <i>Headboard Nilo 90</i>	102 x 135 x 3,3  0,056  1 u	<b>60</b>	<b>67</b>	<b>71</b>	<b>76</b>
	<b>CA086</b> Cabecero Nilo de 105 <i>Headboard Nilo 105</i>	117 x 135 x 3,3  0,064  1 u	<b>69</b>	<b>77</b>	<b>82</b>	<b>88</b>
	<b>CA087</b> Cabecero Nilo de 135 <i>Headboard Nilo 135</i>	147 x 135 x 3,3  0,080  1 u	<b>75</b>	<b>83</b>	<b>89</b>	<b>95</b>
	<b>CA088</b> Cabecero Nilo de 150 <i>Headboard Nilo 150</i>	162 x 135 x 3,3  0,088  1 u	<b>93</b>	<b>103</b>	<b>110</b>	<b>118</b>
	<b>CA089</b> Cabecero Nilo de 160 <i>Headboard Nilo 160</i>	172 x 135 x 3,3  0,094  1 u	<b>99</b>	<b>110</b>	<b>118</b>	<b>126</b>
	<b>CA090</b> Cabecero Nilo de 180 <i>Headboard Nilo 180</i>	192 x 135 x 3,3  0,105  1 u	<b>107</b>	<b>119</b>	<b>127</b>	<b>136</b>
	<b>CA091</b> Cabecero Baviera de 90 <i>Headboard Baviera 90</i>	101 x 117 x 5,5  0,072  1 u	<b>51</b>	<b>57</b>	<b>61</b>	<b>65</b>
	<b>CA092</b> Cabecero Baviera de 105 <i>Headboard Baviera 105</i>	116 x 117 x 5,5  0,083  1 u	<b>53</b>	<b>59</b>	<b>63</b>	<b>67</b>
	<b>CA093</b> Cabecero Baviera de 135 <i>Headboard Baviera 135</i>	146 x 117 x 5,5  0,104  1 u	<b>57</b>	<b>63</b>	<b>67</b>	<b>72</b>
	<b>CA094</b> Cabecero Baviera de 150 <i>Headboard Baviera 150</i>	161 x 117 x 5,5  0,115  1 u	<b>62</b>	<b>68</b>	<b>73</b>	<b>78</b>
	<b>CA095</b> Cabecero Baviera de 160 <i>Headboard Baviera 160</i>	171 x 117 x 5,5  0,122  1 u	<b>66</b>	<b>73</b>	<b>78</b>	<b>83</b>
	<b>CA096</b> Cabecero Baviera de 180 <i>Headboard Baviera 180</i>	191 x 117 x 5,5  0,134  1 u	<b>74</b>	<b>82</b>	<b>88</b>	<b>94</b>



























**Cabeceros madera**  
*Wood Headboard*

Ref.	Descripción <i>Description</i>	Medidas cm <i>Measure cm</i>	Puntos <i>Points</i>			
			A	B	C	A la Arena
	<b>CA097</b> Cabecero Coimbra de 90 <i>Headboard Coimbra 90</i>	104 x 125 x 9,5  0,132  1 u	<b>59</b>	<b>66</b>	<b>71</b>	<b>76</b>
		<b>CA098</b> Cabecero Coimbra de 105 <i>Headboard Coimbra 105</i>	119 x 125 x 9,5  0,151  1 u	<b>67</b>	<b>74</b>	<b>79</b>
	<b>CA099</b> Cabecero Coimbra de 135 <i>Headboard Coimbra 135</i>	149 x 125 x 9,5  0,189  1 u	<b>81</b>	<b>89</b>	<b>96</b>	<b>103</b>
		<b>CA100</b> Cabecero Coimbra de 150 <i>Headboard Coimbra 150</i>	164 x 125 x 9,5  0,208  1 u	<b>85</b>	<b>94</b>	<b>101</b>
	<b>CA101</b> Cabecero Coimbra de 160 <i>Headboard Coimbra 160</i>	174 x 125 x 9,5  0,221  1 u	<b>90</b>	<b>100</b>	<b>107</b>	<b>114</b>
		<b>CA102</b> Cabecero Coimbra de 180 <i>Headboard Coimbra 180</i>	194 x 125 x 9,5  0,246  1 u	<b>94</b>	<b>105</b>	<b>112</b>
	<b>CA103</b> Cabecero Níger de 90 <i>Headboard Níger 90</i>	108 x 117,5 x 7  0,091  1 u	<b>36</b>	<b>40</b>	<b>43</b>	<b>46</b>
		<b>CA104</b> Cabecero Níger de 105 <i>Headboard Níger 105</i>	123 x 117,5 x 7  0,103  1 u	<b>40</b>	<b>45</b>	<b>48</b>
	<b>CA105</b> Cabecero Níger de 135 <i>Headboard Níger 135</i>	153 x 122,5 x 7  0,134  1 u	<b>48</b>	<b>53</b>	<b>57</b>	<b>61</b>
		<b>CA106</b> Cabecero Níger de 150 <i>Headboard Níger 150</i>	168 x 122,5 x 7  0,147  1 u	<b>55</b>	<b>61</b>	<b>65</b>
	<b>CA107</b> Cabecero Níger de 160 <i>Headboard Níger 160</i>	178 x 122,5 x 7  0,156  1 u	<b>58</b>	<b>65</b>	<b>69</b>	<b>74</b>
		<b>CA108</b> Cabecero Níger de 180 <i>Headboard Níger 180</i>	198 x 122,5 x 7  0,173  1 u	<b>68</b>	<b>76</b>	<b>81</b>























**Bancadas**  
*Bedframes*

Ref.	Descripción <i>Description</i>	Medidas cm <i>Measure cm</i>	Puntos <i>Points</i>			
			A	B	C	A la Arena
	<b>BN001</b> Bancada Volga de 135 <i>Bedframe Volga 135</i>	150 x 44 x 199  0,170  1 u	<b>101</b>	<b>112</b>	<b>120</b>	<b>128</b>
		<b>BN002</b> Bancada Volga de 150 <i>Bedframe Volga 150</i>	165 x 44 x 199  0,170  1 u	<b>104</b>	<b>116</b>	<b>124</b>
	<b>BN003</b> Bancada Volga de 160 <i>Bedframe Volga 160</i>	175 x 44 x 199  0,170  1 u	<b>107</b>	<b>119</b>	<b>127</b>	<b>136</b>
		<b>BN004</b> Bancada Volga de 180 <i>Bedframe Volga 180</i>	195 x 44 x 199  0,170  1 u	<b>108</b>	<b>120</b>	<b>129</b>
	<b>BN005</b> Bancada Verona de 90 <i>Bedframe Verona 90</i>	99 x 40 x 199  0,117  1 u	<b>76</b>	<b>84</b>	<b>90</b>	<b>96</b>
		<b>BN006</b> Bancada Verona de 105 <i>Bedframe Verona 105</i>	114 x 40 x 199  0,117  1 u	<b>79</b>	<b>88</b>	<b>94</b>
	<b>BN007</b> Bancada Verona de 135 <i>Bedframe Verona 135</i>	143 x 40 x 199  0,117  1 u	<b>85</b>	<b>94</b>	<b>100</b>	<b>107</b>
		<b>BN008</b> Bancada Verona de 150 <i>Bedframe Verona 150</i>	158 x 40 x 199  0,117  1 u	<b>86</b>	<b>95</b>	<b>102</b>
	<b>BN009</b> Bancada Verona de 160 <i>Bedframe Verona 160</i>	168 x 40 x 199  0,117  1 u	<b>88</b>	<b>98</b>	<b>105</b>	<b>112</b>
		<b>BN010</b> Bancada Verona de 180 <i>Bedframe Verona 180</i>	188 x 40 x 199  0,117  1 u	<b>93</b>	<b>104</b>	<b>111</b>
	<b>BN011</b> Bancada Basilea de 90 <i>Bedframe Basilea 90</i>	102 x 41 x 200  0,143  1 u	<b>87</b>	<b>97</b>	<b>103</b>	<b>110</b>
		<b>BN012</b> Bancada Basilea de 105 <i>Bedframe Mistral 105</i>	117 x 41 x 200  0,143  1 u	<b>90</b>	<b>100</b>	<b>107</b>



















**Bancadas  
Bedframes**

Ref.	Descripción Description	Medidas cm Measure cm	Puntos Points			
			A	B	C	A la Arena
	<b>BN013</b> Bancada Basilea de 135 <i>Bedframe Basilea 135</i>	144 x 40 x 200  0,143  1 u	<b>101</b>	<b>112</b>	<b>120</b>	<b>128</b>
	<b>BN014</b> Bancada Basilea de 150 <i>Bedframe Basilea 150</i>	159 x 40 x 200  0,143  1 u	<b>104</b>	<b>116</b>	<b>124</b>	<b>133</b>
	<b>BN015</b> Bancada Basilea de 160 <i>Bedframe Basilea 160</i>	169 x 40 x 200  0,143  1 u	<b>107</b>	<b>119</b>	<b>127</b>	<b>136</b>
	<b>BN016</b> Bancada Basilea de 180 <i>Bedframe Basilea 180</i>	189 x 40 x 200  0,143  1 u	<b>108</b>	<b>120</b>	<b>129</b>	<b>138</b>
	<b>BN017</b> Bancada Fontana de 90 <i>Bedframe Fontana 90</i>	99 x 41 x 199  0,118  1 u	<b>76</b>	<b>84</b>	<b>90</b>	<b>96</b>
	<b>BN018</b> Bancada Fontana de 105 <i>Bedframe Fontana 105</i>	114 x 41 x 199  0,118  1 u	<b>79</b>	<b>88</b>	<b>94</b>	<b>101</b>
	<b>BN019</b> Bancada Fontana de 135 <i>Bedframe Fontana 135</i>	144 x 41 x 199  0,119  1 u	<b>87</b>	<b>96</b>	<b>103</b>	<b>110</b>
	<b>BN020</b> Bancada Fontana de 150 <i>Bedframe Fontana 150</i>	159 x 41 x 199  0,119  1 u	<b>90</b>	<b>100</b>	<b>107</b>	<b>114</b>
	<b>BN021</b> Bancada Fontana de 160 <i>Bedframe Fontana 160</i>	169 x 41 x 199  0,119  1 u	<b>91</b>	<b>101</b>	<b>108</b>	<b>116</b>
	<b>BN022</b> Bancada Fontana de 180 <i>Bedframe Fontana 180</i>	189 x 41 x 199  0,119  1 u	<b>93</b>	<b>103</b>	<b>110</b>	<b>118</b>
	<b>BN023</b> Bancada Mediterráneo de 90 <i>Bedframe Mediterraneo 90</i>	104 x 40 x 199  0,126  1 u	<b>76</b>	<b>84</b>	<b>90</b>	<b>96</b>
	<b>BN024</b> Bancada Mediterráneo de 105 <i>Bedframe Mediterraneo 105</i>	119 x 40 x 199  0,126  1 u	<b>79</b>	<b>88</b>	<b>94</b>	<b>101</b>

**Bancadas  
Bedframes**

Ref.	Descripción Description	Medidas cm Measure cm	Puntos Points			
			A	B	C	A la Arena
	<b>BN025</b> Bancada Mediterráneo de 135 <i>Bedframe Mediterraneo 135</i>	149 x 40 x 199  0,125  1 u	<b>85</b>	<b>94</b>	<b>100</b>	<b>107</b>
	<b>BN026</b> Bancada Mediterráneo de 150 <i>Bedframe Mediterraneo 150</i>	164 x 40 x 199  0,125  1 u	<b>86</b>	<b>95</b>	<b>102</b>	<b>109</b>
	<b>BN027</b> Bancada Mediterráneo de 160 <i>Bedframe Mediterraneo 160</i>	174 x 40 x 199  0,125  1 u	<b>88</b>	<b>98</b>	<b>105</b>	<b>112</b>
	<b>BN028</b> Bancada Mediterráneo de 180 <i>Bedframe Mediterraneo 180</i>	194 x 40 x 199  0,128  1 u	<b>93</b>	<b>104</b>	<b>111</b>	<b>119</b>
	<b>BN029</b> Bancada Decco de 90 <i>Bedframe Decco 90</i>	98 x 41 x 200  0,136  1 u	<b>76</b>	<b>84</b>	<b>90</b>	<b>96</b>
	<b>BN030</b> Bancada Decco de 105 <i>Bedframe Decco 105</i>	113 x 41 x 200  0,136  1 u	<b>79</b>	<b>88</b>	<b>94</b>	<b>101</b>
	<b>BN031</b> Bancada Decco de 135 <i>Bedframe Decco 135</i>	143 x 41 x 200  0,136  1 u	<b>88</b>	<b>97</b>	<b>104</b>	<b>111</b>
	<b>BN032</b> Bancada Decco de 150 <i>Bedframe Decco 150</i>	158 x 41 x 200  0,136  1 u	<b>90</b>	<b>100</b>	<b>107</b>	<b>114</b>
	<b>BN033</b> Bancada Decco de 160 <i>Bedframe Decco 160</i>	168 x 41 x 200  0,136  1 u	<b>92</b>	<b>102</b>	<b>109</b>	<b>117</b>
	<b>BN034</b> Bancada Decco de 180 <i>Bedframe Decco 180</i>	188 x 41 x 200  0,136  1 u	<b>93</b>	<b>104</b>	<b>111</b>	<b>119</b>

**Banquetas y butacas**  
*Bench and chair*

	Ref.	Descripción <i>Description</i>	Medidas cm <i>Measure cm</i>
	<b>BB001</b>	Banqueta con cajón Basilea <i>Bench with drawer Basilea</i>	92 x 44 x 45  0,186  1 u
	<b>BB002</b>	Banqueta Basilea <i>Bench Basilea</i>	83 x 45 x 43  0,164  1 u
	<b>BB003</b>	Banqueta Fontana <i>Bench Fontana</i>	90 x 65 x 40  0,239  1 u
	<b>BB004</b>	Banqueta Mediterráneo <i>Bench Mediterraneo</i>	114 x 50 x 38  0,221  1 u
	<b>BB005</b>	Butaca Colette <i>Chair Colette</i>	60 x 98 x 60  0,440  1 u
	<b>BB006</b>	Butaca Diana <i>Chair Diana</i>	60 x 98 x 60  0,440  1 u

**Puntos / Points**









































Ver telas y metraje en "Cabeceros Tapizados" pag. 6-7  
*See fabrics and footage in "Upholstered Headboards" pag. 6-7*

	A			B			C			A la arena		
T/cliente	2	3	T/cliente	2	3	T/cliente	2	3	T/cliente	2	3	
<b>73</b>	<b>77</b>	<b>80</b>	<b>81</b>	<b>84</b>	<b>89</b>	<b>87</b>	<b>91</b>	<b>96</b>	<b>93</b>	<b>98</b>	<b>102</b>	
<b>69</b>	<b>71</b>	<b>73</b>	<b>76</b>	<b>78</b>	<b>81</b>	<b>82</b>	<b>85</b>	<b>87</b>	<b>88</b>	<b>90</b>	<b>93</b>	
<b>69</b>	<b>71</b>	<b>73</b>	<b>76</b>	<b>78</b>	<b>81</b>	<b>82</b>	<b>85</b>	<b>87</b>	<b>88</b>	<b>90</b>	<b>93</b>	
<b>64</b>	<b>67</b>	<b>69</b>	<b>71</b>	<b>73</b>	<b>76</b>	<b>76</b>	<b>79</b>	<b>82</b>	<b>82</b>	<b>85</b>	<b>88</b>	
<b>87</b>	<b>95</b>	<b>104</b>	<b>87</b>	<b>95</b>	<b>104</b>	<b>87</b>	<b>95</b>	<b>104</b>	<b>87</b>	<b>95</b>	<b>104</b>	
<b>87</b>	<b>95</b>	<b>104</b>	<b>87</b>	<b>95</b>	<b>104</b>	<b>87</b>	<b>95</b>	<b>104</b>	<b>87</b>	<b>95</b>	<b>104</b>	

























\* NOTA: Estos metrajes son generales, tener en cuenta un sobredimensionamiento de éstos en el caso de que se quiera centrar algún dibujo contenido en la tela.

\* NOTE: This per-metre information is general. Please remember that centring patterns on furniture may require more metres than otherwise.









**Estantes  
y complementos**  
*Wall shelf*

Ref.	Descripción <i>Description</i>	Medidas cm <i>Measure cm</i>	Puntos <i>Points</i>			
			A	B	C	A la Arena
 <b>EC001</b>	Estante de pared de 40 <i>Wall shelf 40</i>	40 x 4 x 20  0,004  1 u	14	16	17	18
 <b>EC002</b>	Estante de pared de 80 <i>Wall shelf 80</i>	80 x 4 x 20  0,009  1 u	17	19	20	21
 <b>EC003</b>	Estante de pared de 90 <i>Wall shelf 90</i>	90 x 4 x 20  0,010  1 u	19	21	23	25
 <b>EC004</b>	Estante de pared de 100 <i>Wall shelf 100</i>	100 x 4 x 20  0,011  1 u	20	22	24	26
 <b>EC005</b>	Estante de pared de 120 <i>Wall shelf 120</i>	120 x 4 x 20  0,013  1 u	22	24	26	28
 <b>EC006</b>	Estante de pared de 130 <i>Wall shelf 130</i>	130 x 4 x 20  0,014  1 u	25	28	30	32
 <b>EC007</b>	Estante de pared de 140 <i>Wall shelf 140</i>	140 x 4 x 20  0,015  1 u	27	30	32	34
 <b>EC008</b>	Estante de pared de 150 <i>Wall shelf 150</i>	150 x 4 x 20  0,016  1 u	28	31	33	35
 <b>EC009</b>	Estante de pared de 160 <i>Wall shelf 160</i>	160 x 4 x 20  0,017  1 u	30	33	36	39
 <b>EC010</b>	Estante de pared de 180 <i>Wall shelf 180</i>	180 x 4 x 20  0,019  1 u	33	37	39	42
 <b>EC011</b>	Estante de pared de 210 <i>Wall shelf 210</i>	210 x 4 x 20  0,022  1 u	36	40	43	46
 <b>EC012</b>	Cubo estante (cuadrado) <i>Square cube shelf</i>	40 x 40 x 25  0,043  1 u	21	23	25	27
 <b>EC013</b>	Cubo estante (rectangular) <i>Rectangular cube shelf</i>	70 x 35 x 25  0,070  1 u	32	36	38	41
 <b>EC014</b>	Cubo estante doble <i>Double cube shelf</i>	95 x 55 x 25  0,137  1 u	56	62	66	71









**Estantes  
y complementos**  
*Wall shelf*

Ref.	Descripción <i>Description</i>	Medidas cm <i>Measure cm</i>	Puntos <i>Points</i>			
			A	B	C	A la Arena
 <b>EC015</b>	Juego de bucks de piel <i>Set leather bucks</i>	 0,044  1 u	26	26	26	26
 <b>EC016</b>	Espejo Narcea (metálico) <i>Metallic mirror Narcea</i>	70 x 98 x 6  0,050  1 u	65	65	65	65
 <b>CD010</b>	Espejo trípico Cerdeña <i>Cerdeña 3-panel mirror</i>	119 X 110 X 3,3  0,050  1 u	74	82	88	95
 <b>VD015</b>	Espejo vestidor Verona <i>Dressing mirror Verona</i>	60 x 143 x 2,5  0,026  1 u	52	57	61	65
 <b>BD015</b>	Espejo de 94 x 86 sin celosía Basilea <i>Basilea mirror 94 x 86, no latticework</i>	94 x 86 x 6  0,058  1 u	46	51	55	59
 <b>BD017</b>	Espejo de 66 x 63 Basilea <i>Mirror Basilea</i>	66 x 63 x 6  0,027  1 u	55	57	61	65
 <b>FC004</b>	Espejo de 65x 82 Fontana <i>Mirror Fontana</i>	65 x 82 x 3  0,022  1 u	34	38	40	43
 <b>FC002</b>	Percha puerta abatible Fontana <i>Fontana coat stand w/ foldout door</i>	64 x 170 x 20  0,254  1 u	93	103	110	118





















**ARMARIOS**  
Closets

Ref.	Descripción Description	Medidas cm Measure cm	Puntos Points			
			A	B	C	A la Arena
 <b>BA001</b>	Armario de 2 puertas cristal-visillo Basilea <i>Closet Basilea with 2 glass doors</i>	118 x 240 x 63 <small>m<sup>2</sup> 0,450 u 5</small>	<b>326</b>	<b>358</b>	<b>387</b>	<b>414</b>
 <b>BA002</b>	Armario de 3 puertas cristal-visillo Basilea <i>Closet Basilea with 3 glass doors</i>	172 x 240 x 63 <small>m<sup>2</sup> 0,590 u 5</small>	<b>472</b>	<b>519</b>	<b>560</b>	<b>600</b>
 <b>BA003</b>	Armario de 4 puertas cristal-visillo Basilea <i>Closet Basilea with 4 glass doors</i>	225 x 240 x 63 <small>m<sup>2</sup> 0,670 u 6</small>	<b>551</b>	<b>606</b>	<b>655</b>	<b>701</b>
 <b>DA005</b>	Armario de 2 puertas cristal-visillo Decco de 240 <i>Closet Decco with 2 glass doors 240</i>	118 x 240 x 63 <small>m<sup>2</sup> 0,450 u 5</small>	<b>326</b>	<b>358</b>	<b>387</b>	<b>414</b>
 <b>DA006</b>	Armario de 3 puertas cristal-visillo Decco de 240 <i>Closet Decco with 3 glass doors 240</i>	172 x 240 x 63 <small>m<sup>2</sup> 0,590 u 5</small>	<b>472</b>	<b>519</b>	<b>560</b>	<b>600</b>
 <b>DA007</b>	Armario de 4 puertas cristal-visillo Decco de 240 <i>Closet Decco with 4 glass doors 240</i>	225 x 240 x 63 <small>m<sup>2</sup> 0,670 u 6</small>	<b>551</b>	<b>606</b>	<b>655</b>	<b>701</b>
 <b>FA001</b>	Armario de 2 puertas cristal-visillo Fontana <i>Closet Fontana with 2 glass doors</i>	118 x 240 x 63 <small>m<sup>2</sup> 0,450 u 5</small>	<b>326</b>	<b>358</b>	<b>387</b>	<b>414</b>
 <b>FA002</b>	Armario de 3 puertas cristal-visillo Fontana <i>Closet Fontana with 3 glass doors</i>	172 x 240 x 63 <small>m<sup>2</sup> 0,590 u 5</small>	<b>472</b>	<b>519</b>	<b>560</b>	<b>600</b>

**ARMARIOS**  
Closets

Ref.	Descripción Description	Medidas cm Measure cm	Puntos Points			
			A	B	C	A la Arena
 <b>FA003</b>	Armario de 4 puertas cristal-visillo Fontana <i>Closet Fontana with 4 glass doors</i>	225 x 240 x 63 <small>m<sup>2</sup> 0,670 u 6</small>	<b>551</b>	<b>606</b>	<b>655</b>	<b>701</b>
 <b>MA001</b>	Armario de 2 puertas cristal-visillo Mediterráneo <i>Closet Mediterraneo with 2 glass doors</i>	118 x 240 x 63 <small>m<sup>2</sup> 0,450 u 5</small>	<b>326</b>	<b>358</b>	<b>387</b>	<b>414</b>
 <b>MA002</b>	Armario de 3 puertas cristal-visillo Mediterráneo <i>Closet Mediterraneo with 3 glass doors</i>	172 x 240 x 63 <small>m<sup>2</sup> 0,590 u 5</small>	<b>472</b>	<b>519</b>	<b>560</b>	<b>600</b>
 <b>MA003</b>	Armario de 4 puertas cristal-visillo Mediterráneo <i>Closet Mediterraneo with 4 glass doors</i>	225 x 240 x 63 <small>m<sup>2</sup> 0,670 u 6</small>	<b>551</b>	<b>606</b>	<b>655</b>	<b>701</b>
 <b>VA001</b>	Armario de 2 puertas Verona <i>Closet Verona with 2 doors</i>	118 x 240 x 63 <small>m<sup>2</sup> 0,450 u 5</small>	<b>326</b>	<b>358</b>	<b>387</b>	<b>414</b>
 <b>VA002</b>	Armario de 3 puertas Verona <i>Closet Verona with 3 doors</i>	172 x 240 x 63 <small>m<sup>2</sup> 0,590 u 5</small>	<b>472</b>	<b>519</b>	<b>560</b>	<b>600</b>
 <b>VA003</b>	Armario de 4 puertas Verona <i>Closet Verona with 4 doors</i>	225 x 240 x 63 <small>m<sup>2</sup> 0,670 u 6</small>	<b>551</b>	<b>606</b>	<b>655</b>	<b>701</b>
 <b>AA001</b>	Armario de 2 puertas Alcira <i>Closet Alcira with 2 doors</i>	118 x 240 x 63 <small>m<sup>2</sup> 0,450 u 5</small>	<b>326</b>	<b>358</b>	<b>387</b>	<b>414</b>

**ARMARIOS**  
Closets

Ref.	Descripción Description	Medidas cm Measure cm	Puntos Points			
			A	B	C	A la Arena
 <b>AA002</b>	Armario de 3 puertas Alcira <i>Closet Alcira with 3 doors</i>	172 x 240 x 63  0,590  5 u 	<b>472</b>	<b>519</b>	<b>560</b>	<b>600</b>
 <b>AA003</b>	Armario de 4 puertas Alcira <i>Closet Alcira with 4 doors</i>	225 x 240 x 63  0,670  6 u 				
 <b>NA001</b>	Armario de 2 puertas madera Níger <i>Closet Níger with 2 doors</i>	114 x 212 x 60  0,500  4 u 				
 <b>NA002</b>	Armario de 2 puertas cristal-visillo Níger <i>Closet Níger with 2 glass doors</i>	114 x 212 x 60  0,500  4 u 				
 <b>NA003</b>	Armario de 3 puertas madera Níger <i>Closet Níger with 3 doors</i>	166 x 212 x 60  0,730  6 u 				
 <b>NA004</b>	Armario de 3 puertas cristal-visillo Níger <i>Closet Níger with 3 glass doors</i>	166 x 212 x 60  0,730  6 u 				
 <b>PA005</b>	Armario puertas corredera de 210 <i>Closet sliding doors 210</i>	210 x 240 x 63  1,199  7 u 				

Distribución interior armarios  
Inner distribution of module

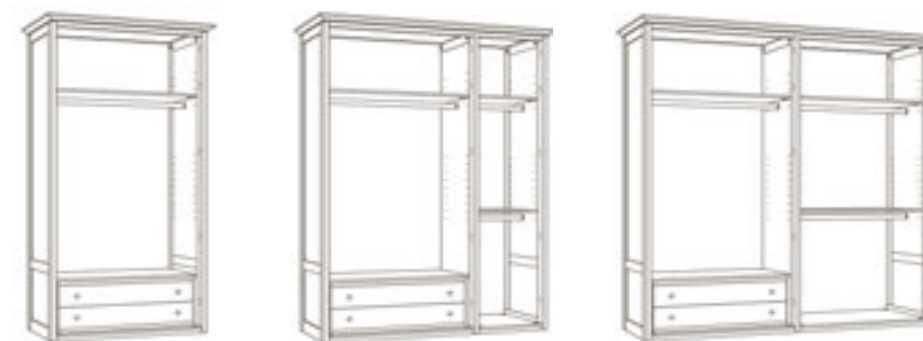

Distribución interior armarios puertas correderas  
Inner distribution of Sliding doors module



Distribución interior armarios Níger  
Inner distribution of Níger module





# COLECCIÓN AMBERES

Collection **AMBERES**

DORMITORIOS  
BEDROOMS



























**COLECCIÓN Amberes**  
Collection Amberes

Ref.

**Descripción**  
Description

**Medidas cm**  
Measure cm

**Puntos**  
Points

			A	B	C	A la Arena
	<b>AD001</b> Mesita 1 cajón Amberes <i>Bedside table</i> Amberes 1 drawer	49 x 69 x 40  0,140  1 u	59	65	70	75
	<b>AD002</b> Mesita 3 cajones Amberes <i>Bedside table</i> Amberes 3 drawers	49 x 69 x 40  0,140  1 u	70	77	83	89
	<b>AD003</b> Mesita 1 cajón de ancho 70 cm Amberes <i>Bedside table</i> Amberes width 70	70 x 69 x 40  0,200  1 u	76	83	90	96
	<b>AD004</b> Mesita 3 cajones de ancho 70 cm Amberes <i>Bedside table 3 drawers</i> Amberes	70 x 69 x 40  0,200  1 u	92	101	109	116
	<b>AD005</b> Cómoda Amberes <i>Chest of drawers</i> Amberes	108 x 114 x 44  0,537  1 u	208	229	248	265
	<b>AD006</b> Cómoda con puerta Amberes <i>Chest with doors</i> Amberes	108 x 123 x 44  0,594  1 u	244	269	290	310
	<b>AD007</b> Sinfonier Amberes <i>Chiffonier</i> Amberes	70 x 123 x 44  0,385  1 u	168	185	199	213
	<b>AD008</b> Escritorio fijo Amberes <i>Writing desk</i> Amberes	122 x 77 x 54  0,520  1 u	132	145	156	167













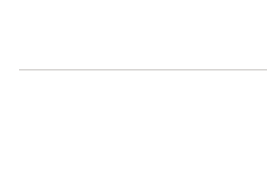

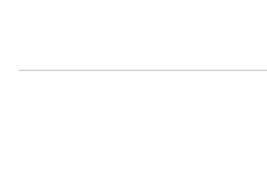

**COLECCIÓN Amberes**  
Collection Amberes

Ref.

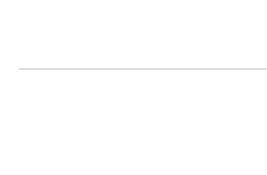
**Descripción**  
Description

**Medidas cm**  
Measure cm

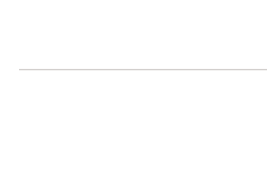
**Puntos**  
Points

			A	B	C	A la Arena
	<b>AD009</b> Escritorio desmontable cajonera derecha Amberes (Tapa 140-170 cm) <i>Amberes disassemblable right-drawer desk (top 140-170 cm)</i>	140 - 170 x 78 x 50  2 u	113	124	134	144
	<b>AD010</b> Escritorio desmontable cajonera derecha Amberes (Tapa 171-200 cm) <i>Amberes disassemblable right-drawer desk (top 171-200 cm)</i>	171 - 200 x 78 x 50  2 u	122	134	145	155
	<b>AD011</b> Escritorio desmontable cajonera izquierda Amberes (Tapa 140-170 cm) <i>Amberes disassemblable left-drawer desk (top 140-170 cm)</i>	140 - 170 x 78 x 50  2 u	113	124	134	144
	<b>AD012</b> Escritorio desmontable cajonera izquierda Amberes (Tapa 171-200 cm) <i>Amberes disassemblable left-drawer desk (top 171-200 cm)</i>	171 - 200 x 78 x 50  2 u	122	134	145	155
	<b>AD013</b> Escritorio desmontable cajonera central Amberes (Tapa 180-210 cm) <i>Amberes disassemblable central-drawer desk (top 180-210 cm)</i>	180 - 210 x 78 x 50  2 u	142	157	169	181
	<b>AD014</b> Escritorio desmontable cajonera central Amberes (Tapa 211-260 cm) <i>Amberes disassemblable central-drawer desk (top 211-260 cm)</i>	211 - 260 x 78 x 50  2 u	151	166	180	192
	<b>AD015</b> Escritorio desmontable doble cajonera Amberes (Tapa 160-210 cm) <i>Amberes disassemblable drawer desk (top 160-210 cm)</i>	160-210 x 78 x 50  3 u	167	184	198	212
	<b>AD016</b> Escritorio desmontable doble cajonera Amberes (Tapa 211-260 cm) <i>Amberes disassemblable drawer desk (top 211-260 cm)</i>	211 - 260 x 78 x 50  3 u	175	192	208	222

**COLECCIÓN Amberes**  
Collection Amberes

Ref.

**Descripción**  
Description

**Medidas cm**  
Measure cm

**Puntos**  
Points

			A	B	C	A la Arena
	<b>AC005</b> Bureau Amberes <i>Amberes Bureau</i>	112 x 148 x 44	284	312	337	361
		0,735            2 u				
	<b>AC008</b> Librero Amberes <i>Bookcase cabinet Amberes</i>	112 x 200 x 44	248	273	295	316
		0,994            2 u				
	<b>AC014</b> Bajo cajón Amberes <i>Low module Amberes with drawer</i>	108 x 75 x 44	111	122	132	141
		0,359            1 u				











# COLECCIÓN CERDEÑA

## Collection CERDEÑA



















DORMITORIOS  
BEDROOMS



**COLECCIÓN Cerdeña**  
Collection Cerdeña

Ref.	Descripción Description	Medidas cm Measure cm	Puntos Points			
			A	B	C	A la Arena
 <b>CD001</b>	Mesita 1 cajón Cerdeña <i>Bedside table 1 drawer Cerdeña</i>	49 x 68 x 39  0,129   1 u	<b>53</b>	<b>59</b>	<b>64</b>	<b>68</b>
 <b>CD002</b>	Mesita 3 cajones Cerdeña <i>Bedside table 3 drawers Cerdeña</i>	49 x 68 x 39  0,129   1 u	<b>67</b>	<b>74</b>	<b>80</b>	<b>86</b>
 <b>CD003</b>	Mesita ancho 36 cm Cerdeña <i>Bedside table 36 cm Cerdeña</i>	36 x 68 x 39  0,095   1 u	<b>49</b>	<b>54</b>	<b>59</b>	<b>63</b>
 <b>CD010</b>	Espejo trípico Cerdeña <i>Cerdeña 3-panel mirror</i>	119 X 110 X 3,3  0,050   1 u	<b>74</b>	<b>82</b>	<b>88</b>	<b>95</b>
 <b>CD004</b>	Comodín Cerdeña <i>Chest of drawers Cerdeña</i>	133 x 85 x 43  0,491   1 u	<b>208</b>	<b>229</b>	<b>248</b>	<b>265</b>
 <b>CD005</b>	Cómoda Cerdeña <i>Chest of drawers Cerdeña</i>	103 x 105 x 43  0,474   1 u	<b>189</b>	<b>208</b>	<b>225</b>	<b>241</b>

**COLECCIÓN Cerdeña**  
Collection Cerdeña

Ref.	Descripción Description	Medidas cm Measure cm	Puntos Points			
			A	B	C	A la Arena
 <b>CD006</b>	Cómoda con puerta Cerdeña <i>Chest with door Cerdeña</i>	103 x 121 x 43  0,547   1 u	<b>237</b>	<b>260</b>	<b>281</b>	<b>301</b>
 <b>CD007</b>	Sinfonier Cerdeña <i>Cerdeña chiffonier</i>	70 x 121 x 43  0,371   1 u	<b>162</b>	<b>179</b>	<b>193</b>	<b>206</b>
 <b>CD008</b>	Mesa de estudio Cerdeña <i>Cerdeña study desk</i>	121 x 78 x 54  0,517   1 u	<b>105</b>	<b>116</b>	<b>125</b>	<b>134</b>
 <b>CD009</b>	Escritorio Cerdeña <i>Cerdeña desk</i>	121 x 78 x 54  0,517   1 u	<b>130</b>	<b>143</b>	<b>154</b>	<b>165</b>
 <b>CC006</b>	Librero Cerdeña <i>Cerdeña Bookcase</i>	138 x 200 x 43  1,200   2 u	<b>370</b>	<b>407</b>	<b>439</b>	<b>470</b>
 <b>CC013</b>	Bajo cajón Cerdeña <i>Low module Cerdeña with drawer</i>	91 x 57 x 39  0,210   1 u	<b>81</b>	<b>89</b>	<b>96</b>	<b>103</b>



















# COLECCIÓN VOLGA

**Collection VOLGA**

DORMITORIOS  
BEDROOMS



**COLECCIÓN Volga**  
Collection Volga

	Ref.	Descripción Description	Medidas cm Measure cm	Puntos Points			
				A	B	C	A la Arena
	<b>XD001</b>	Mesita cajones Volga Bedside table with drawers Volga	60 x 67 x 39  0,165   1 u	<b>83</b>	<b>92</b>	<b>98</b>	<b>105</b>
	<b>XD002</b>	Mesita puerta cristal-visillo y cajón Volga Bedside table Volga with glass door & drawer	60 x 67 x 39  0,165   1 u	<b>79</b>	<b>88</b>	<b>94</b>	<b>101</b>
	<b>XD003</b>	Mesita puerta madera y cajón Volga Bedside table Volga with door & drawer	60 x 67 x 39  0,165   1 u	<b>79</b>	<b>88</b>	<b>94</b>	<b>101</b>
	<b>XD004</b>	Cómoda Volga Chest of drawers Volga	112 x 115 x 45,5  0,600   1 u	<b>211</b>	<b>233</b>	<b>249</b>	<b>266</b>
	<b>XD005</b>	Sinfonier Volga Chiffonier Volga	84 x 115 x 45,5  0,446   1 u	<b>180</b>	<b>199</b>	<b>212</b>	<b>227</b>
	<b>XC003</b>	Librero Volga Bookcase cabinet Volga	88 x 206 x 45  0,832   1 u	<b>191</b>	<b>210</b>	<b>227</b>	<b>242</b>



















# COLECCIÓN NANTES

## Collection NANTES

DORMITORIOS  
BEDROOMS 



**COLECCIÓN Nantes**  
Collection Nantes

Ref.	Descripción Description	Medidas cm Measure cm	Puntos Points			
			A	B	C	A la Arena
 <b>ND001</b>	Mesita 1 cajón Nantes <i>Bedside table Nantes 1 drawer</i>	45 x 70 x 39	<b>47</b>	<b>51</b>	<b>55</b>	<b>59</b>
		 0,123  1 u				
 <b>ND002</b>	Mesita cajones Nantes <i>Bedside table Nantes drawers</i>	45 x 70 x 39	<b>62</b>	<b>69</b>	<b>74</b>	<b>79</b>
		 0,123  1 u				
 <b>ND003</b>	Comodín Nantes <i>Chest of drawers Nantes</i>	103 x 93 x 44	<b>149</b>	<b>164</b>	<b>177</b>	<b>190</b>
		 0,425  1 u				
 <b>ND004</b>	Cómoda Nantes <i>Chest of drawers Nantes</i>	103 x 114 x 44	<b>182</b>	<b>200</b>	<b>216</b>	<b>231</b>
		 0,519  1 u				
 <b>ND005</b>	Sinfonier Nantes <i>Chiffonier Nantes</i>	70 x 114 x 44	<b>140</b>	<b>153</b>	<b>166</b>	<b>177</b>
		 0,353  1 u				
 <b>ND006</b>	Escritorio Nantes <i>Writing desk Nantes</i>	115 x 77 x 53	<b>113</b>	<b>125</b>	<b>135</b>	<b>144</b>
		 0,476  1 u				



























# COLECCIÓN VERONA

## Collection VERONA

























DORMITORIOS  
BEDROOMS 



**COLECCIÓN Verona**  
Collection Verona

Ref.	Descripción Description	Medidas cm Measure cm	Puntos Points			
			A	B	C	A la Arena
 <b>VD001</b>	Mesita cajones Verona <i>Bedside Verona with drawers</i>	48 x 70 x 38  0,134  1 u	<b>63</b>	<b>69</b>	<b>73</b>	<b>78</b>
 <b>VD002</b>	Mesita puerta derecha cristal-visillo y cajón Verona <i>Bedside table Verona with right door &amp; drawer</i>	48 x 70 x 38  0,134  1 u	<b>59</b>	<b>65</b>	<b>69</b>	<b>74</b>
 <b>VD003</b>	Mesita puerta izquierda cristal-visillo y cajón Verona <i>Bedside table Verona with left door &amp; drawer</i>	48 x 70 x 38  0,134  1 u	<b>59</b>	<b>65</b>	<b>69</b>	<b>74</b>
 <b>VD004</b>	Mesita puerta derecha madera y cajón Verona <i>Bedside table Verona with right drawer</i>	48 x 70 x 38  0,134  1 u	<b>59</b>	<b>65</b>	<b>69</b>	<b>74</b>
 <b>VD005</b>	Mesita puerta izquierda madera y cajón Verona <i>Bedside table Verona with left &amp; drawer</i>	48 x 70 x 38  0,134  1 u	<b>59</b>	<b>65</b>	<b>69</b>	<b>74</b>
 <b>VD006</b>	Mesita cajón y hueco Verona <i>Bedside table Verona with drawer &amp; hollow</i>	48 x 70 x 38  0,134  1 u	<b>50</b>	<b>56</b>	<b>60</b>	<b>64</b>
 <b>VD007</b>	Mesita ancho 65 cm Verona <i>Bedside table 65 Verona</i>	65 x 70 x 38  0,180  1 u	<b>59</b>	<b>65</b>	<b>69</b>	<b>74</b>
 <b>VD008</b>	Mesita ancho 36 cm Verona <i>Bedside table 36 Verona</i>	36 x 70 x 38  0,101  1 u	<b>43</b>	<b>48</b>	<b>51</b>	<b>55</b>
 <b>VD009</b>	Cómoda Verona <i>Chest of drawers Verona</i>	101 x 110 x 41,5  0,480  1 u	<b>168</b>	<b>185</b>	<b>198</b>	<b>212</b>

**COLECCIÓN Verona**  
Collection Verona

Ref.	Descripción Description	Medidas cm Measure cm	Puntos Points			
			A	B	C	A la Arena
 <b>VD010</b>	Sinfonier Verona <i>Chiffonier Verona</i>	72 x 115 x 41,5  0,356  1 u	<b>150</b>	<b>165</b>	<b>176</b>	<b>188</b>
 <b>VD011</b>	Zapatero Verona <i>Shoe module Verona</i>	66 x 106 x 40  0,314  1 u	<b>105</b>	<b>116</b>	<b>124</b>	<b>133</b>
 <b>VD012</b>	Mesa de estudio Verona <i>Writing desk Verona</i>	110 x 84 x 55  0,524  1 u	<b>96</b>	<b>106</b>	<b>113</b>	<b>121</b>
 <b>VD013</b>	Escritorio Verona <i>Writing desk Verona</i>	110 x 84 x 55  0,524  1 u	<b>128</b>	<b>141</b>	<b>150</b>	<b>161</b>
 <b>VD014</b>	Librero de 77 Verona <i>Bookcase cabinet Verona</i>	77 x 170 x 37  0,494  1 u	<b>119</b>	<b>132</b>	<b>141</b>	<b>151</b>
 <b>VD015</b>	Espejo vestidor Verona <i>Dressing mirror Verona</i>	60 x 143 x 2,5  0,026  1 u	<b>52</b>	<b>57</b>	<b>61</b>	<b>65</b>
 <b>VD016</b>	Perchero con estantes Verona <i>Verona coat rack with shelves</i>	70 x 55,5 x 25  0,103  1 u	<b>48</b>	<b>54</b>	<b>58</b>	<b>62</b>
 <b>VD017</b>	Baúl puertas Verona <i>Trunk with doors Verona</i>	100 x 53 x 36,5  0,202  1 u	<b>76</b>	<b>85</b>	<b>91</b>	<b>97</b>





























# COLECCIÓN BASILEA

Collection **BASILEA**

























DORMITORIOS  
BEDROOMS 



COLECCIÓN Basilea  
Collection Basilea

Ref.	Descripción Description	Medidas cm Measure cm	Puntos Points			
			A	B	C	A la Arena
 <b>BD001</b>	Mesita cajones Basilea <i>Bedside table Basilea with drawers</i>	49,5 x 70 x 39,5  0,142  1 u	<b>69</b>	<b>76</b>	<b>81</b>	<b>87</b>
 <b>BD002</b>	Mesita puerta derecha cristal-visillo y cajón Basilea <i>Bedside table Basilea with right door &amp; drawer</i>	49,5 x 70 x 39,5  0,142  1 u	<b>65</b>	<b>72</b>	<b>77</b>	<b>82</b>
 <b>BD003</b>	Mesita puerta izquierda cristal-visillo y cajón Basilea <i>Bedside table Basilea with left door &amp; drawer</i>	49,5 x 70 x 39,5  0,142  1 u	<b>65</b>	<b>72</b>	<b>77</b>	<b>82</b>
 <b>BD004</b>	Mesita puerta derecha madera y cajón Basilea <i>Bedside table Basilea with right door &amp; drawer</i>	49,5 x 70 x 39,5  0,142  1 u	<b>65</b>	<b>72</b>	<b>77</b>	<b>82</b>
 <b>BD005</b>	Mesita puerta izquierda madera y cajón Basilea <i>Bedside table Basilea with left door &amp; drawer</i>	49,5 x 70 x 39,5  0,142  1 u	<b>65</b>	<b>72</b>	<b>77</b>	<b>82</b>
 <b>BD006</b>	Mesita cajón y hueco Basilea <i>Bedside table Basilea with drawer &amp; hollow</i>	52 x 70 x 39,5  0,149  1 u	<b>65</b>	<b>72</b>	<b>77</b>	<b>82</b>
 <b>BD007</b>	Comodín Basilea <i>Chest of drawers Basilea</i>	109 x 94,5 x 46,5  0,491  1 u	<b>150</b>	<b>165</b>	<b>176</b>	<b>188</b>
 <b>BD008</b>	Cómoda Basilea <i>Chest of drawers Basilea</i>	109 x 110 x 46,5  0,571  1 u	<b>198</b>	<b>218</b>	<b>232</b>	<b>248</b>
 <b>BD009</b>	Sinfonier Basilea <i>Chiffonier Basilea</i>	74 x 124,5 x 46,5  0,441  1 u	<b>179</b>	<b>197</b>	<b>210</b>	<b>225</b>

COLECCIÓN Basilea  
Collection Basilea

Ref.	Descripción Description	Medidas cm Measure cm	Puntos Points			
			A	B	C	A la Arena
 <b>BD010</b>	Atillo escritorio Basilea (sin guías metálicas) <i>High module writing desk Basilea (without metal guides)</i>	116 x 19 x 30  0,071  1 u	<b>46</b>	<b>51</b>	<b>55</b>	<b>59</b>
 <b>BD011</b>	Mesa de estudio Basilea <i>Writing desk Basilea</i>	125 x 77 x 59,5  0,586  1 u	<b>112</b>	<b>124</b>	<b>133</b>	<b>142</b>
 <b>BD012</b>	Escritorio Basilea <i>Writing desk Basilea</i>	125 x 77 x 59,5  0,586  1 u	<b>130</b>	<b>143</b>	<b>153</b>	<b>164</b>
 <b>BD013</b>	Librero de 74 Basilea <i>Bookcase cabinet 74 Basilea</i>	74 x 125 x 39  0,363  1 u	<b>120</b>	<b>133</b>	<b>142</b>	<b>152</b>
 <b>BD014</b>	Espejo de 94 x 86 Basilea <i>Mirror 94 x 86 Basilea</i>	94 x 86 x 6  0,058  1 u	<b>61</b>	<b>68</b>	<b>72</b>	<b>77</b>
 <b>BD015</b>	Espejo de 94 x 86 sin celosía Basilea <i>Mirror 94 x 86 Basilea</i>	94 x 86 x 6  0,058  1 u	<b>46</b>	<b>51</b>	<b>55</b>	<b>59</b>
 <b>BD016</b>	Espejo de 94 x 134 Basilea <i>Mirror 94 x 134 Basilea</i>	94 x 134 x 6  0,090  1 u	<b>75</b>	<b>83</b>	<b>89</b>	<b>95</b>
 <b>BD017</b>	Espejo de 66 x 63 Basilea <i>Mirror 66 x 63 Basilea</i>	66 x 63 x 6  0,027  1 u	<b>55</b>	<b>57</b>	<b>61</b>	<b>65</b>



























# COLECCIÓN FONTANA

## Collection FONTANA





















DORMITORIOS  
BEDROOMS























COLECCIÓN Fontana  
Collection Fontana

Ref.	Descripción Description	Medidas cm Measure cm	Puntos Points			
			A	B	C	A la Arena
 <b>FD001</b>	Mesita puerta derecha cristal-visillo y cajón Fontana <i>Bedside table Fontana with right door &amp; drawer</i>	46 x 72 x 40  0,141  1 u	65	72	77	82
 <b>FD002</b>	Mesita puerta izquierda cristal-visillo y cajón Fontana <i>Bedside table Fontana with left door &amp; drawer</i>	46 x 72 x 40  0,141  1 u	65	72	77	82
 <b>FD003</b>	Mesita puerta derecha madera y cajón Fontana <i>Bedside table Fontana with right door &amp; drawer</i>	46 x 72 x 40  0,141  1 u	65	72	77	82
 <b>FD004</b>	Mesita puerta izquierda madera y cajón Fontana <i>Bedside table Fontana with left door &amp; drawer</i>	46 x 72 x 40  0,141  1 u	65	72	77	82
 <b>FD005</b>	Mesita cajones Fontana <i>Bedside table Fontana with drawers</i>	46 x 72 x 40  0,141  1 u	69	76	81	87
 <b>FD006</b>	Mesita 2 puertas cristal-visillo de ancho 75 cm Fontana <i>Bedside table Fontana with glass door &amp; 2 drawer</i>	75 x 72 x 40  0,227  1 u	94	103	110	118
 <b>FD007</b>	Mesita 2 puertas madera de ancho 75 cm Fontana <i>Bedside table Fontana with 2 doors</i>	75 x 72 x 40  0,227  1 u	94	103	110	118
 <b>FD008</b>	Mesita cajones ancho 75 cm Fontana <i>Bedside table Fontana with drawers</i>	75 x 72 x 40  0,227  1 u	98	107	114	122
 <b>FD009</b>	Mesita ancho 30 cm Fontana (sin guías metálicas) <i>Bedside table Fontana special width 30 (without metal guides)</i>	30 x 72 x 30  0,093  1 u	53	58	62	66

COLECCIÓN Fontana  
Collection Fontana

Ref.	Descripción Description	Medidas cm Measure cm	Puntos Points			
			A	B	C	A la Arena
 <b>FC004</b>	Espejo de 65 x 82 Fontana <i>Mirror Fontana</i>	65 x 82 x 3  0,022  1 u	34	38	40	43
 <b>FD010</b>	Comodín 5 cajones Fontana <i>Chest of drawers Fontana with 5 drawers</i>	110 x 85 x 45  0,439  1 u	152	167	178	190
 <b>FD011</b>	Cómoda puertas cristal-visillo Fontana <i>Chest of drawers Fontana with doors</i>	110 x 115 x 45  0,586  1 u	190	208	222	238
 <b>FD012</b>	Cómoda puertas madera Fontana <i>Chest of drawers Fontana</i>	110 x 115 x 45  0,586  1 u	190	208	222	238
 <b>FD013</b>	Atillo escritorio Fontana <i>High module writing desk Fontana</i>	120 x 37 x 32  0,152  1 u	83	92	98	105
 <b>FD014</b>	Mesa de estudio Fontana <i>Writing desk Fontana</i>	120 x 77 x 53  0,510  1 u	119	131	139	149
 <b>FD015</b>	Escritorio 4 cajones Fontana <i>Writing desk Fontana with 4 drawers</i>	120 x 77 x 53  0,505  1 u	126	138	147	157

			A	B	C	A la Arena
	<b>FD016</b> Sinfonier 5 cajones y puertas cristal-visillo Fontana <i>Chiffonier 5 drawers and doors wood</i>	75 x 120 x 45  0,418  1 u	<b>153</b>	<b>167</b>	<b>178</b>	<b>190</b>
	<b>FD017</b> Sinfonier 5 cajones y puertas madera Fontana <i>Chiffonier 5 drawers and doors mader</i>	75 x 120 x 45  0,418  1 u	<b>153</b>	<b>167</b>	<b>178</b>	<b>190</b>
	<b>FD018</b> Sinfonier 7 cajones Fontana <i>Chiffonier 7 drawers Fontana</i>	75 x 120 x 45  0,418  1 u	<b>157</b>	<b>171</b>	<b>182</b>	<b>195</b>
	<b>FC016</b> Librero de 75 Fontana <i>Bookcase cabinet 75 Fontana</i>	75 x 200 x 40  0,600  1 u	<b>187</b>	<b>206</b>	<b>220</b>	<b>235</b>
	<b>FC018</b> Librero de 130 Fontana <i>Bookcase cabinet 130 Fontana</i>	130 x 80 x 39  0,405  1 u	<b>154</b>	<b>169</b>	<b>181</b>	<b>194</b>
	<b>FC002</b> Percha puerta abatible Fontana <i>Dressing with rank Fontana</i>	64 x 170 x 20  0,254  1 u	<b>93</b>	<b>103</b>	<b>110</b>	<b>118</b>
	<b>FC026</b> Bajo cajones Fontana <i>Low module Fontana with drawers</i>	110 x 53 x 40  0,246  1 u	<b>94</b>	<b>104</b>	<b>111</b>	<b>119</b>

























# COLECCIÓN MEDITERRANEO

## Collection MEDITERRANEO





















DORMITORIOS  
BEDROOMS 















**COLECCIÓN**  
**Mediterráneo**  
*Collection Mediterraneo*

Ref.	Descripción <i>Description</i>	Medidas cm <i>Measure cm</i>	Puntos <i>Points</i>			
			A	B	C	A la Arena
 <b>MD001</b>	Mesita puerta derecha cristal-visillo y cajón Mediterraneo <i>Bedside table Mediterraneo with right door &amp; drawer</i>	48 x 71 x 39  0,141  1 u	<b>65</b>	<b>72</b>	<b>77</b>	<b>82</b>
 <b>MD002</b>	Mesita puerta izquierda cristal-visillo y cajón Mediterraneo <i>Bedside table Mediterraneo with left door &amp; drawer</i>	48 x 71 x 39  0,141  1 u	<b>65</b>	<b>72</b>	<b>77</b>	<b>82</b>
 <b>MD003</b>	Mesita puerta derecha madera y cajón Mediterraneo <i>Bedside table Fontana with right door &amp; drawer</i>	48 x 71 x 39  0,141  1 u	<b>65</b>	<b>72</b>	<b>77</b>	<b>82</b>
 <b>MD004</b>	Mesita puerta izquierda madera y cajón Mediterraneo <i>Bedside table Fontana with left door &amp; drawer</i>	48 x 71 x 39  0,141  1 u	<b>65</b>	<b>72</b>	<b>77</b>	<b>82</b>
 <b>MD005</b>	Mesita cajones Mediterraneo <i>Bedside table drawers Mediterraneo</i>	48 x 71 x 39  0,141  1 u	<b>69</b>	<b>76</b>	<b>81</b>	<b>87</b>
 <b>MD006</b>	Mesita ancho 67 cm Mediterraneo <i>Bedside table 67 Mediterraneo</i>	67 x 71 x 39  0,196  1 u	<b>72</b>	<b>79</b>	<b>84</b>	<b>90</b>
 <b>MD007</b>	Mesita ancho 35 cm Mediterraneo <i>Bedside table 35 Mediterraneo</i>	35 x 71 x 39  0,104  1 u	<b>55</b>	<b>60</b>	<b>64</b>	<b>68</b>
 <b>MD008</b>	Espejo Mediterraneo <i>Mirror Mediterraneo</i>	59 x 85 x 6  0,034  1 u	<b>61</b>	<b>67</b>	<b>72</b>	<b>77</b>

**COLECCIÓN**  
**Mediterráneo**  
*Collection Mediterraneo*

Ref.	Descripción <i>Description</i>	Medidas cm <i>Measure cm</i>	Puntos <i>Points</i>			
			A	B	C	A la Arena
 <b>MD009</b>	Comodín Mediterraneo <i>Chest of drawers Mediterraneo</i>	110 x 85 x 45  0,435  1 u	<b>152</b>	<b>167</b>	<b>178</b>	<b>190</b>
 <b>MD010</b>	Cómoda Mediterraneo <i>Chest of drawers Mediterraneo</i>	110 x 119 x 45  0,606  1 u	<b>214</b>	<b>234</b>	<b>249</b>	<b>266</b>
 <b>MD011</b>	Sinfonier puerta cristal-visillo Mediterraneo <i>Chiffonier Mediterraneo</i>	80 x 130 x 45  0,483  1 u	<b>178</b>	<b>196</b>	<b>209</b>	<b>224</b>
 <b>MD012</b>	Sinfonier puerta madera Mediterraneo <i>Chiffonier Mediterraneo</i>	80 x 130 x 45  0,483  1 u	<b>178</b>	<b>196</b>	<b>209</b>	<b>224</b>
 <b>MD013</b>	Altillo escritorio Mediterraneo <i>High module writing desk Mediterraneo</i>	122 x 50 x 27  0,176  1 u	<b>87</b>	<b>96</b>	<b>103</b>	<b>110</b>
 <b>MD014</b>	Mesa estudio Mediterraneo <i>Writing desk Mediterraneo</i>	125 x 77 x 55  0,550  1 u	<b>119</b>	<b>130</b>	<b>139</b>	<b>149</b>
 <b>MD015</b>	Escritorio Mediterraneo <i>Writing desk Mediterraneo</i>	125 x 77 x 55  0,550  1 u	<b>130</b>	<b>143</b>	<b>153</b>	<b>164</b>





















	Ref.	Descripción Description	Medidas cm Measure cm	Puntos Points			A la Arena
				A	B	C	
	<b>MC009</b>	Librero de 80 Mediterráneo <i>Bookcase cabinet 80 Mediterraneo</i>	80 x 130 x 45  0,483   1 u	<b>166</b>	<b>182</b>	<b>195</b>	<b>208</b>
	<b>MD016</b>	Espejo vestidor Mediterráneo <i>Dressing mirror Mediterraneo</i>	67 x 134 x 6  0,060   1 u	<b>67</b>	<b>74</b>	<b>79</b>	<b>85</b>
	<b>MD017</b>	Baúl Mediterráneo <i>Trunk Mediterraneo</i>	91 x 46 x 44  0,195   1 u	<b>70</b>	<b>77</b>	<b>82</b>	<b>88</b>
	<b>MC013</b>	Bajo cajones Mediterráneo <i>Low module Mediterraneo with drawers</i>	129 x 57 x 45  0,343   1 u	<b>124</b>	<b>136</b>	<b>145</b>	<b>155</b>





















# COLECCIÓN DECCO

## Collection DECCO

DORMITORIOS  
BEDROOMS 





Ref.	Descripción Description	Medidas cm Measure cm	Puntos Points			
			A	B	C	A la Arena
 <b>DD001</b>	Mesita puerta derecha cristal-visillo y cajón Decco <i>Bedside table Decco with right door &amp; drawer</i>	45 x 73 x 39  0,134  1 u	<b>65</b>	<b>72</b>	<b>77</b>	<b>82</b>
 <b>DD002</b>	Mesita puerta izquierda cristal-visillo y cajón Decco <i>Bedside table Decco with left door &amp; drawer</i>	45 x 73 x 39  0,134  1 u	<b>65</b>	<b>72</b>	<b>77</b>	<b>82</b>
 <b>DD003</b>	Mesita cajones Decco <i>Bedside table drawers Decco</i>	45 x 73 x 39  0,134  1 u	<b>69</b>	<b>76</b>	<b>81</b>	<b>87</b>
 <b>DD004</b>	Espejo tríptico joyero comodín Decco (sin guías metálicas) <i>Chest of drawers Decco with mirror &amp; jewellery box (without metal guides)</i>	100 x 85 x 17  0,066  2 u	<b>76</b>	<b>85</b>	<b>91</b>	<b>97</b>
 <b>DD005</b>	Comodín Decco <i>Chest of drawers Decco</i>	111 x 86 x 48  0,475  1 u	<b>170</b>	<b>185</b>	<b>199</b>	<b>212</b>
 <b>DD006</b>	Cómoda Decco <i>Chest of drawers Decco</i>	116 x 113 x 48  0,651  1 u	<b>192</b>	<b>214</b>	<b>228</b>	<b>244</b>
 <b>DD007</b>	Cómoda con espejo Decco <i>Chest of drawers with mirror Decco</i>	116 x 153 x 48  0,680  2 u	<b>224</b>	<b>249</b>	<b>266</b>	<b>285</b>

Ref.	Descripción Description	Medidas cm Measure cm	Puntos Points			
			A	B	C	A la Arena
 <b>DD008</b>	Sinfonier Decco <i>Decco chiffonier</i>	75 x 124 x 48  0,461  1 u	<b>163</b>	<b>179</b>	<b>190</b>	<b>203</b>
 <b>DD009</b>	Altito mesa escritorio Decco (sin guías metálicas) <i>Decco desktop unit (without metal guides)</i>	120 x 39 x 31  0,152  1 u	<b>56</b>	<b>63</b>	<b>67</b>	<b>72</b>
 <b>DD010</b>	Mesa escritorio Decco <i>Decco desk</i>	123 x 75 x 53  0,501  1 u	<b>119</b>	<b>132</b>	<b>141</b>	<b>151</b>
 <b>DD011</b>	Librero pequeño Decco <i>Small Decco bookcase</i>	75 x 100 x 39  0,304  1 u	<b>94</b>	<b>104</b>	<b>111</b>	<b>119</b>
 <b>DD012</b>	Baúl Decco <i>Decco chest</i>	96 x 49 x 44  0,215  1 u	<b>77</b>	<b>86</b>	<b>92</b>	<b>98</b>
 <b>DA001</b>	Armario 2 puertas madera Decco Clásico <i>Decco Clasico wardrobe, 2 wooden doors</i>	112 x 215 x 65  0,661  4 u	<b>280</b>	<b>310</b>	<b>332</b>	<b>355</b>
 <b>DA002</b>	Armario 2 puertas cristal-visillo Decco Clásico <i>Decco Clasico wardrobe, 2 glass/curtain doors</i>	112 x 215 x 65  0,661  4 u	<b>280</b>	<b>310</b>	<b>332</b>	<b>355</b>



COLECCIÓN **Decco**  
Collection Decco

Ref.	Descripción Description	Medidas cm Measure cm	Puntos Points			A la Arena
			A	B	C	
 <b>DA003</b>	Armario 3 puertas madera Decco Clásico <i>Closet Decco with 3 doors</i>	175 x 215 x 65  0,967  7 u	453	501	536	573
 <b>DA004</b>	Armario 3 puertas cristal-visillo Decco Clásico <i>Closet Decco with 3 glass doors</i>	175 x 215 x 65  0,967  7 u	453	501	536	573

\* En la medidas se expresan las alturas sin copete, la altura de este será de 7 cm. (Ref. DD001-DD002-DD003-DD005-DD006-DD008)  
\* Measurements are given without crowns, finials or top-pieces, which are 7 cm in height. (Ref. DD001-DD002-DD003-DD005-DD006-DD008)

Distribución interior armarios **Decco Clásico**  
Inner distribution of Decco module



ASAS (distancia de taladro a taladro 64 mm) HANDLES (drilling distance to drill 64 mm)

					
Asa Fontana	Asa Mediterráneo	Asa Decco	Asa Verona	Asa Amberes	Asa Cerdeña

- Las asas podrán ser intercambiables entre las colecciones: Fontana, Mediterráneo, Decco, Verona, Amberes, Cerdeña y Nantes.
- El asa Mediterráneo sólo podrá ser utilizada en la serie Mediterráneo.
- Todas las asas serán metálicas con acabado oro envejecido y/o plata envejecida.
- Todos los pedidos deberán incluir el modelo y color de asa.
- Handles or pulls are interchangeable among the following collections: Fontana, Mediterráneo, Decco, Verona, Amberes, Cerdeña and Nantes.
- The Mediterráneo handle can only be used with the Mediterráneo series.
- All handles are in metal with aged gold and/or aged silver finishes.
- All orders must include handle model and colour.

POMOS KNOBS

						
Pomo ø 30mm metálico	Pomo ø 30mm madera	Pomo ø 45mm metálico	Pomo ø 45mm madera	Pomo bandejas	Pomo Decco	Pomo Fontana

- Los pomos podrán ser intercambiables entre las colecciones Fontana, Mediterráneo y Decco.
- En las bandejas sólo se podrá utilizar el "Pomo bandejas".
- Todos los pomos metálicos tendrán acabado oro viejo y/o plata vieja.
- Todos los pomos de madera se podrán tener cualquier acabado A, B, C o A LA ARENA.
- Todos los pedidos deberán incluir el modelo y color de pomo.
- All knobs are interchangeable among the Fontana, Mediterráneo and Decco collections.
- For trays, only "Tray knobs" can be used.
- All metal knobs are in aged gold and/or aged silver finishes.
- All wood knobs may have any finish: A, B, C or SANDBLASTED.
- All orders must include knob model and colour.



























# PROGRAMA LIBRERIAS

## Libraries Program































DORMITORIOS  
BEDROOMS 



Para altura  
88 cm con puertas Ref.  
Height 88 cm with doors

Ref.	Descripción Description	Medidas cm Measure cm	Puntos Points			A la Arena
			A	B	C	
 <b>EL002</b>	Costado izquierdo madera de 88 para puertas <i>Left wood side panel 88 for doors</i>	35 x 84,9 x 3,2  0,015  1 u	14	16	17	18
 <b>EL004</b>	Costado derecho madera de 88 para puertas <i>Right wood side panel 88 for doors</i>	35 x 84,9 x 3,2  0,015  1 u	14	16	17	18
 <b>EL006</b>	Costado central madera de 88 para puertas <i>Central wood side panel 160 for doors</i>	35 x 84,9 x 3,2  0,015  1 u	17	18	20	21
 <b>EL007</b>	Trasera módulo 2 puertas de 88 <i>Back panel for 2-door module 160</i>	95 x 80 x 0,6  0,005  1 u	6	7	8	9
 <b>EL008</b>	Trasera módulo 1 puerta de 88 <i>Back panel for 1-door module 160</i>	48,6 x 80 x 0,6  0,002  1 u	3	4	5	6
 <b>EL042</b>	Techo módulo 1 puerta para altura 88 y 160 <i>Top panel for 1-door module for heights 88 and 160</i>	34,3 x 46,6 x 1,9  0,003  1 u	9	10	11	12
 <b>EL043</b>	Techo módulo 2 puerta para altura 88 y 160 <i>Top panel for 2-door module for heights 88 and 160</i>	34,3 x 93 x 1,9  0,006  1 u	15	17	18	20
 <b>EL048</b>	Estante módulo 1 puerta <i>1-door module shelf</i>	30,3 x 46,6 x 1,9  0,003  1 u	8	9	10	11
 <b>EL049</b>	Estante módulo 2 puerta <i>2-door module shelf</i>	30,3 x 93 x 1,9  0,005  1 u	15	16	18	19

Para altura  
88 cm con puertas Ref.  
Height 88 cm with doors

Ref.	Descripción Description	Medidas cm Measure cm	Puntos Points			A la Arena
			A	B	C	
 <b>EL050</b>	Base módulo 1 puerta <i>1-door module base</i>	35 x 46,6 x 5  0,008  1 u	12	13	14	15
 <b>EL051</b>	Base módulo 2 puerta <i>2-door module base</i>	35 x 93 x 5  0,017  1 u	21	23	25	27
 <b>EL054</b>	Puerta baja cristal para altura de 88 y 240 <i>Low glass door for heights 88 and 240</i>	46,2 x 77,6 x 2,5  0,009  1 u	11	12	13	14
 <b>EL055</b>	Puerta baja madera para altura de 88 y 240 <i>Low wood door for heights 88 and 240</i>	46,2 x 77,6 x 2,5  0,009  1 u	18	20	22	23
 <b>EL056</b>	Tapa 1 módulo de 1 puerta para altura 88 y 160 <i>Top panel for 1-door module for heights 88 and 160</i>	56 x 38 x 3  0,007  1 u	11	12	13	14
 <b>EL057</b>	Tapa 1 módulo de 2 puertas para altura 88 y 160 <i>Top panel for 2-door module for heights 88 and 160</i>	105 x 39 x 3  0,013  1 u	19	20	22	24
 <b>EL058</b>	Tapa 1 módulo de 1 puerta y 1 de 2 puertas para altura de 88 y 160 <i>Top panel for 1-door module plus 2-door module for heights 88 and 160</i>	152 x 38 x 3  0,018  1 u	26	29	31	33
 <b>EL059</b>	Tapa 2 módulos de 2 puertas para altura de 88 y 160 <i>Top panel for 2-door double module for heights 88 and 160</i>	198 x 38 x 3  0,023  1 u	33	37	40	43
 <b>EL060</b>	Tapa 1 módulo de 1 puerta y 2 de 2 puertas para altura 88 y 160 <i>Top panel for 1-door module plus 2-door double module for heights 88 and 160</i>	248 x 38 x 3  0,029  1 u	53	58	62	67
 <b>EL061</b>	Tapa 3 módulos de 2 puertas para altura de 88 y 160 <i>Top panel for three 2-door modules for heights 88 and 160</i>	295 x 38 x 3  0,034  1 u	62	68	73	79

Para altura 88 cm con puertas  
Height 88 cm with doors

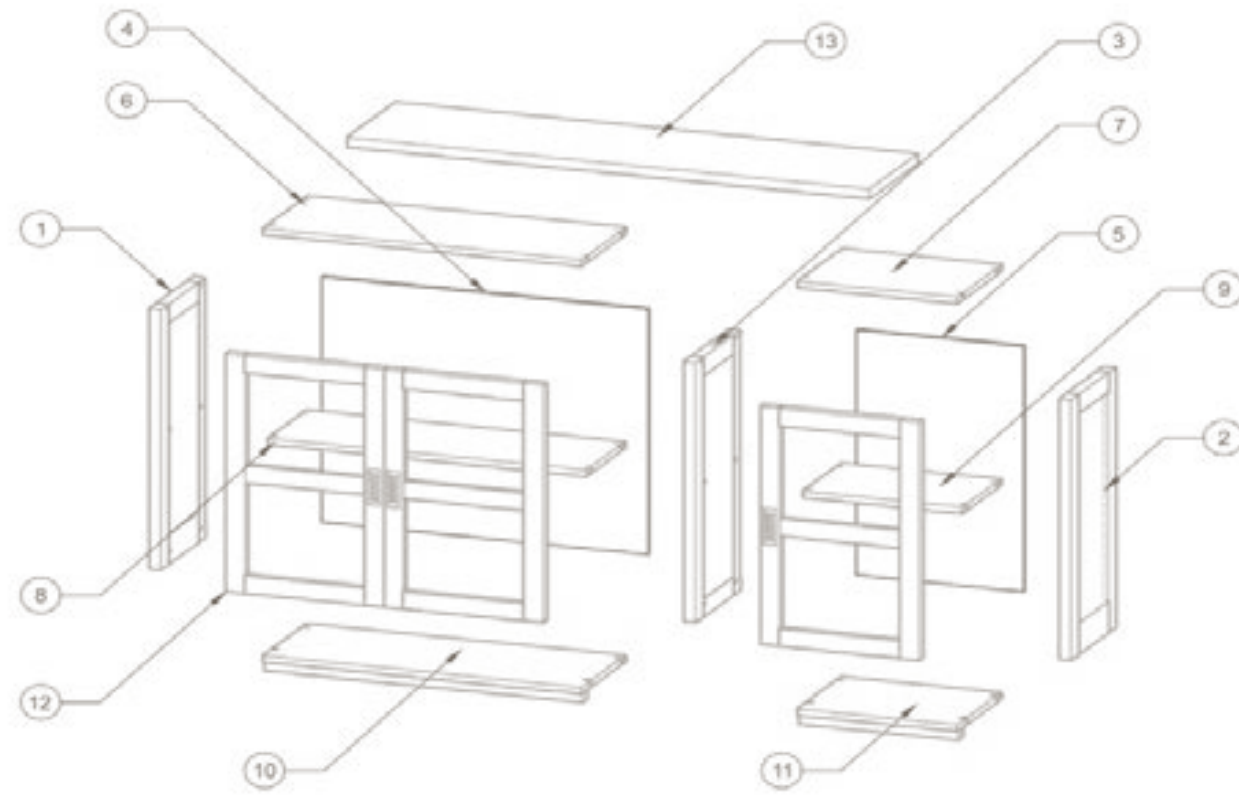

1	EL002	Costado izquierdo madera de 88 para puertas
2	EL004	Costado derecho madera de 88 para puertas
3	EL006	Costado central madera de 88 para puertas
4	EL007	Trasera módulo 2 puertas de 88
5	EL008	Trasera módulo 1 puerta de 88
7	EL042	Techo módulo 1 puerta para altura 88 y 160
6	EL043	Techo módulo 2 puerta para altura 88 y 160



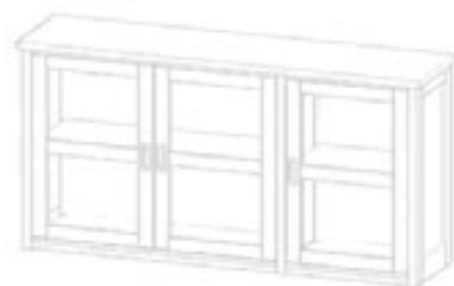





























9	EL048	Estante módulo 1 puerta
8	EL049	Estante módulo 2 puerta
11	EL050	Base módulo 1 puerta
10	EL051	Base módulo 2 puerta
12	EL054 EL055	Puerta baja cristal o madera para altura de 88 y 240
13	EL058	Tapa 1 módulo de 1 puerta y 1 de 2 puertas para altura de 88 y 160









Para altura 160 cm  
con puertas  
Height 160 cm with doors

Ref.	Descripción Description	Medidas cm Measure cm	Puntos Points			
			A	B	C	A la Arena
 EL009	Costado izquierdo cristal de 160 Left glass side panel 160	35 x 157 x 3,2  0,020  1 u	16	17	19	20
 EL010	Costado derecho cristal de 160 Right glass side panel 240	35 x 157 x 3,2  0,020  1 u	16	17	19	20
 EL012	Costado izquierdo madera de 160 para puertas Left wood side panel 160 for doors	35 x 157 x 3,2  0,020  1 u	24	26	28	30
 EL014	Costado derecho madera de 160 para puertas Right wood side panel 160 for doors	35 x 157 x 3,2  0,020  1 u	24	26	28	30
 EL016	Costado central de 160 para puertas Central wood side panel 160 for doors	35 x 157 x 3,2  0,020  1 u	15	17	18	20
 EL017	Trasera módulo 2 puertas de 160 Back panel for 2-door module 160	95 x 152,1 x 0,6  0,009  1 u	12	13	14	15
 EL018	Trasera módulo 1 puerta de 160 Back panel for 1-door module 160	48,6 x 152,1 x 0,6  0,005  1 u	6	7	8	9

Para altura 160 cm  
con puertas  
Height 160 cm with doors

Ref.	Descripción Description	Medidas cm Measure cm	Puntos Points			
			A	B	C	A la Arena
 <b>EL042</b>	Techo módulo 1 puerta para altura 88 y 160 <i>Top panel for 1-door module for heights 88 and 160</i>	34,3 x 46,6 x 1,9  0,003  1 u	4	5	6	7
 <b>EL043</b>	Techo módulo 2 puertas para altura 88 y 160 <i>Top panel for 2-door module for heights 88 and 160</i>	34,3 x 93 x 1,9  0,006  1 u	4	5	6	7
 <b>EL048</b>	Estante módulo 1 puerta <i>1-door module shelf</i>	30,3 x 46,6 x 1,9  0,003  1 u	8	9	10	11
 <b>EL049</b>	Estante módulo 2 puertas <i>2-door module shelf</i>	30,3 x 93 x 1,9  0,005  1 u	15	16	18	19
 <b>EL050</b>	Base módulo 1 puerta <i>1-door module base</i>	35 x 46,6 x 5  0,008  1 u	12	13	14	15
 <b>EL051</b>	Base módulo 2 puertas <i>2-door module base</i>	35 x 93 x 5  0,017  1 u	21	23	25	27
 <b>EL052</b>	Puerta alta cristal para altura de 160 y 240 <i>High glass door for heights 160 and 240</i>	46,2 x 149,7 x 2,5  0,018  1 u	15	17	18	20
 <b>EL056</b>	Tapa 1 módulo de 1 puerta para altura 88 y 160 <i>Top panel for 1-door module for heights 88 and 160</i>	56 x 38 x 3  0,007  1 u	11	12	13	14
 <b>EL057</b>	Tapa 1 módulo de 2 puertas para altura 88 y 160 <i>Top panel for 2-door module for heights 88 and 160</i>	105 x 39 x 3  0,013  1 u	19	20	22	24
 <b>EL058</b>	Tapa 1 módulo de 1 puerta y 1 de 2 puertas para altura de 88 y 160 <i>Top panel for 1-door module plus 2-door module for heights 88 and 160</i>	152 x 38 x 3  0,018  1 u	26	29	31	33
 <b>EL059</b>	Tapa 2 módulos de 2 puertas para altura de 88 y 160 <i>Top panel for 2-door double module for heights 88 and 160</i>	198 x 38 x 3  0,023  1 u	33	37	40	43

Para altura 160 cm  
con puertas  
Height 160 cm with doors

Ref.	Descripción Description	Medidas cm Measure cm	Puntos Points			
			A	B	C	A la Arena
 <b>EL060</b>	Tapa 1 módulo de 1 puerta y 2 de 2 puertas para altura 88 y 160 <i>Top panel for 1-door module plus 2-door double module for heights 88 and 160</i>	248 x 38 x 3  0,029  1 u	53	58	62	67
 <b>EL061</b>	Tapa 3 módulos de 2 puertas para altura de 88 y 160 <i>Top panel for three 2-door modules for heights 88 and 160</i>	295 x 38 x 3  0,034  1 u	62	68	73	79



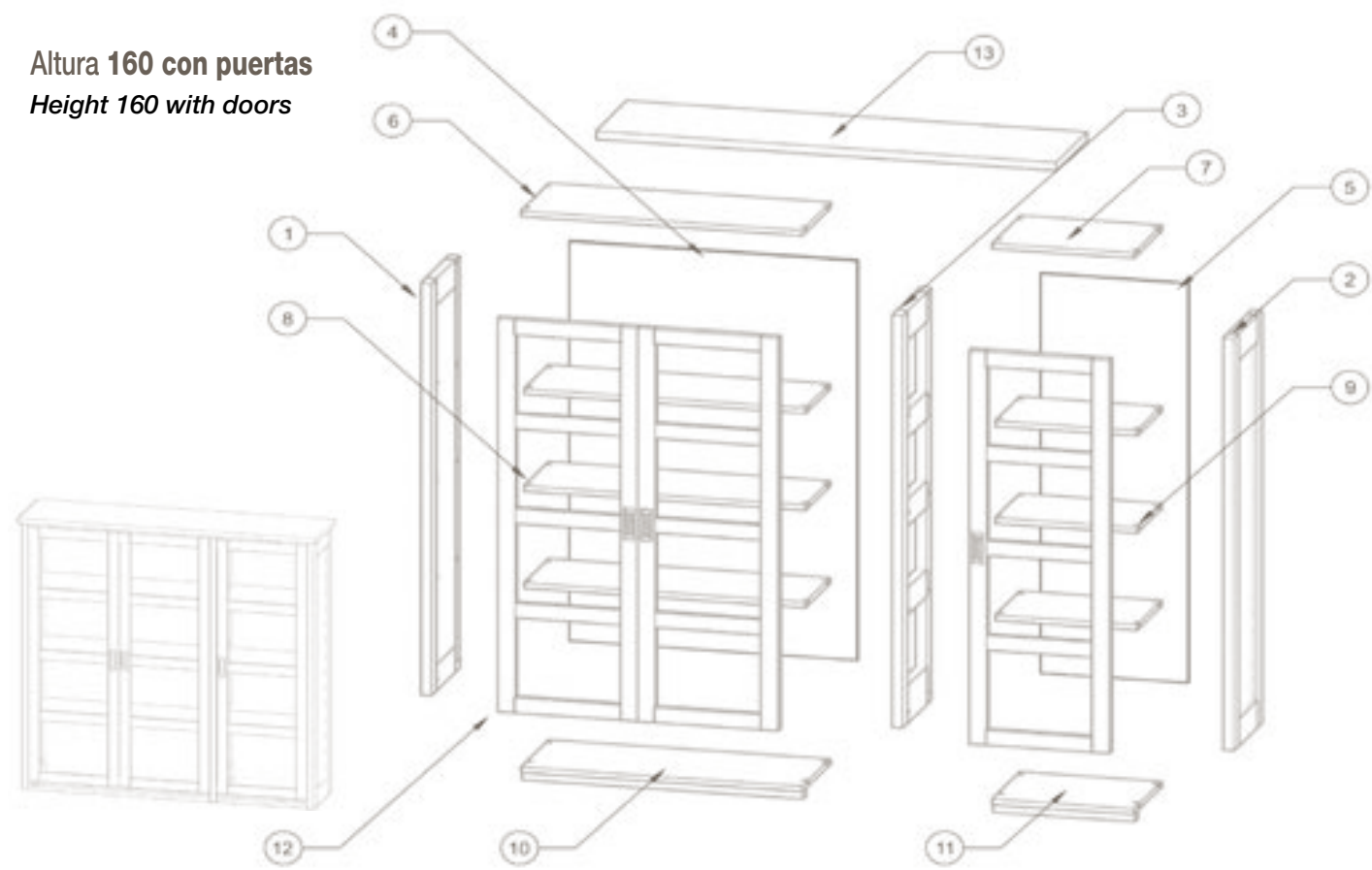

















Altura 160 con puertas  
Height 160 with doors





















1	EL009 EL012	Costado izquierdo cristal o madera de 160 para puerta
2	EL010 EL014	Costado derecho cristal o madera de 160 para puerta
3	EL016	Costado central de 160 para puertas
4	EL017	Trasera módulo 2 puertas de 160
5	EL018	Trasera módulo 1 puerta altura 160
6	EL043	Techo módulo 2 puertas altura 88 y 160
7	EL042	Techo módulo 1 puerta altura 88 y 160

8	EL049	Estante módulo 2 puertas, x3 en esta composición
9	EL048	Estante módulo 1 puerta, x3 en esta composición
10	EL051	Base módulo 2 puerta
11	EL050	Base módulo 1 puerta
12	EL052	Puerta cristal alta par altura 160 y 240, x3 en esta composición
13	EL058	Tapa para altura 88 y 160, largo según número de módulos

Para altura 200 cm  
con puertas  
Height 200 cm with doors

Ref.	Descripción Description	Medidas cm Measure cm	Puntos Points			
			A	B	C	A la Arena
 <b>EL019</b>	Costado izquierdo cristal de 200 <i>Left glass side panel 200</i>	36,5 x 201 x 4,7  0,035  1 u	26	28	30	33
 <b>EL020</b>	Costado derecho cristal de 200 <i>Right glass side panel 200</i>	36,5 x 201 x 4,7  0,035  1 u	26	28	30	33
 <b>EL022</b>	Costado izquierdo madera de 200 para puertas <i>Left wood side panel 200 for doors</i>	36,5 x 201 x 4,7  0,035  1 u	32	35	38	40
 <b>EL024</b>	Costado derecho madera de 200 para puertas <i>Right wood side panel 200 for doors</i>	36,5 x 201 x 4,7  0,35  1 u	32	35	38	40
 <b>EL026</b>	Costado central de 200 para puertas <i>Central wood side panel 200 for doors</i>	36,5 x 201 x 4,7  0,35  1 u	19	21	23	24
 <b>EL027</b>	Trasera módulo 2 puertas de 200 <i>Back panel for 2-door module 200</i>	95 x 192 x 0,6  0,011  1 u	14	16	17	18
 <b>EL028</b>	Trasera módulo 1 puerta de 200 <i>Back panel for 1-door module 200</i>	48,6 x 192 x 0,6  0,006  1 u	7	8	9	10

Para altura 200 cm  
con puertas  
Height 200 cm with doors

Ref.	Descripción Description	Medidas cm Measure cm	Puntos Points			
			A	B	C	A la Arena
 <b>EL044</b>	Techo módulo 1 puerta para altura 200 y 240 <i>Top panel for 1-door module for heights 200 and 240</i>	36 x 46 x 5  0,008  1 u	10	11	12	12
 <b>EL045</b>	Techo módulo 2 puerta para altura 200 y 240 <i>Top panel for 2-door module for heights 200 and 240</i>	36 x 93 x 5  0,017  1 u	17	19	20	22
 <b>EL048</b>	Estante módulo 1 puerta <i>1-door module shelf</i>	30,3 x 46,6 x 1,9  0,003  1 u	8	9	10	11
 <b>EL049</b>	Estante módulo 2 puerta <i>2-door module shelf</i>	30,3 x 93 x 1,9  0,005  1 u	15	16	18	19
 <b>EL050</b>	Base módulo 1 puerta <i>1-door module base</i>	35 x 46,6 x 5  0,008  1 u	12	13	14	15
 <b>EL051</b>	Base módulo 2 puerta <i>2-door module base</i>	35 x 93 x 5  0,017  1 u	21	23	25	27
 <b>EL053</b>	Puerta izquierda cristal para altura 200 <i>Left glass door for height 200</i>	46,2 x 190,7 x 2,5  0,027  1 u	27	29	31	34
 <b>EL062</b>	Puerta derecha cristal para altura 200 <i>Right glass door for height 200</i>					

Para altura 200 cm  
con puertas  
Height 200 cm with doors

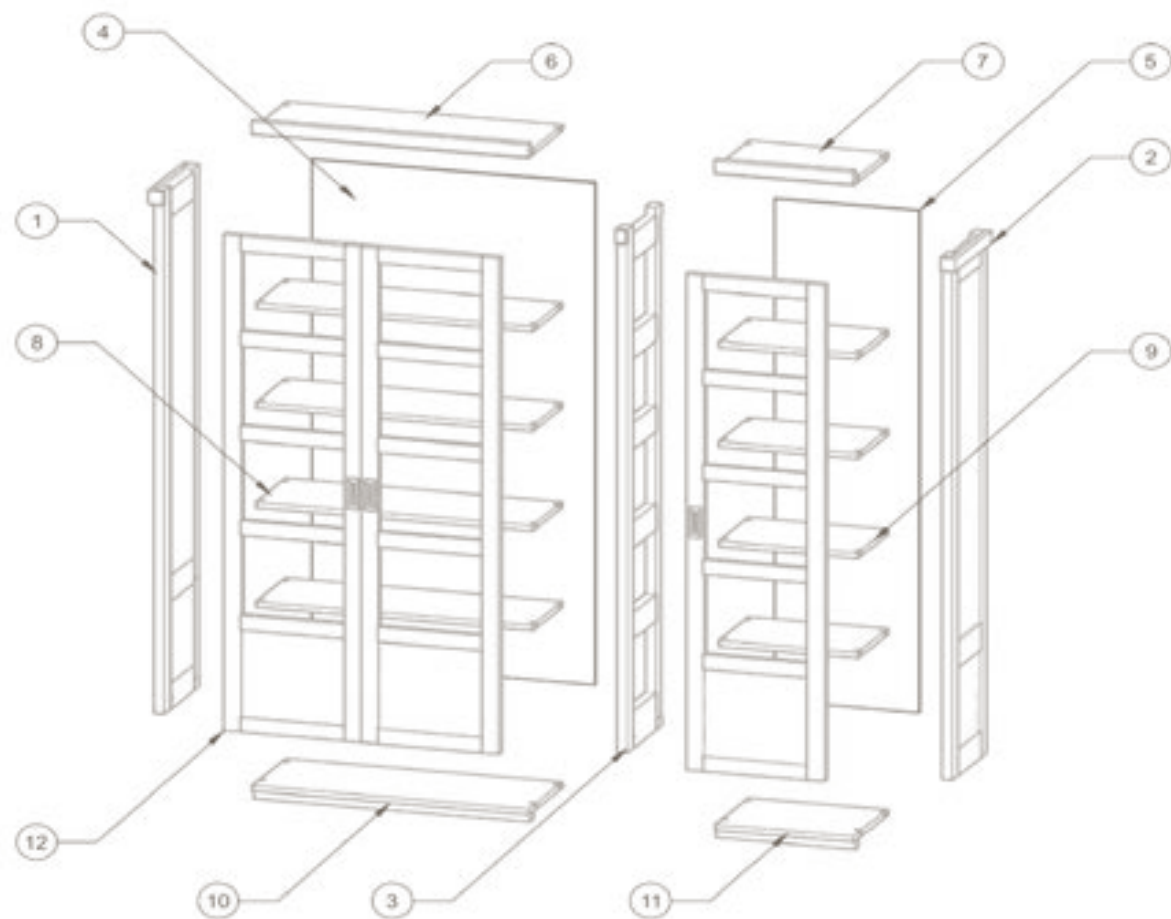

1	EL019 EL022	Costado izquierdo cristal o madera de 200 para puerta
2	EL020 EL024	Costado derecho cristal o madera de 200 para puerta
3	EL026	Costado central de 200 para puertas
4	EL027	Trasera módulo 2 puertas de 200
5	EL028	Trasera módulo 1 puerta altura 200
6	EL045	Techo módulo 2 puertas altura 200 y 240





















7	EL044	Techo módulo 1 puerta para altura 200 y 240
8	EL049	Estante módulo 2 puertas x4 en esta composición
9	EL048	Estante módulo 1 puertas x4 en esta composición
10	EL051	Base módulo 2 puertas
11	EL050	Base módulo 1 puerta
12	EL053 EL062	Puerta izquierda o derecha para altura 200, x1 izquierda y x2 derecha en esta composición























Para altura 240 cm  
con puertas  
Height 240 cm with doors

Ref.	Descripción Description	Medidas cm Measure cm	Puntos Points			
			A	B	C	A la Arena
EL029	Costado izquierdo cristal de 240 Left glass side panel 240	36,5 x 240 x 4,7 0,042 m <sup>3</sup> 1 u	29	32	35	37
EL030	Costado derecho cristal de 240 Right glass side panel 160	36,5 x 240 x 4,7 0,042 m <sup>3</sup> 1 u	29	32	35	37
EL032	Costado izquierdo madera de 240 para puertas alta y baja Left wood side panel 240 for upper and lower doors	36,5 x 240 x 4,7 0,042 m <sup>3</sup> 1 u	36	40	43	46
EL033	Costado izquierdo madera de 240 para puerta baja Left wood side panel 240 for lower door	36,5 x 240 x 4,7 0,042 m <sup>3</sup> 1 u	36	40	43	46
EL035	Costado derecho madera de 240 para puertas alta y baja Right wood side panel 240 for upper and lower doors	36,5 x 240 x 4,7 0,042 m <sup>3</sup> 1 u	36	40	43	46
EL036	Costado derecho madera de 240 para puerta baja Right wood side panel 240 for lower door	36,5 x 240 x 4,7 0,042 m <sup>3</sup> 1 u	36	40	43	46
EL038	Costado central madera de 240 para puertas alta y baja Central wood side panel 240 for upper and lower doors	36,5 x 240 x 4,7 0,042 m <sup>3</sup> 1 u	30	33	36	38

Para altura 240 cm  
con puertas  
Height 240 cm with doors

Ref.	Descripción Description	Medidas cm Measure cm	Puntos Points			
			A	B	C	A la Arena
 <b>EL039</b>	Costado central madera de 240 para puerta baja <i>Central wood side panel 240 for lower door</i>	36,5 x 240 x 4,7  0,042   1 u	<b>30</b>	<b>33</b>	<b>36</b>	<b>38</b>
 <b>EL040</b>	Trasera módulo 2 puertas de 240 <i>Back panel for 2-door module 240</i>	95 x 232 x 0,6  0,013   1 u	<b>17</b>	<b>18</b>	<b>20</b>	<b>21</b>
 <b>EL041</b>	Trasera módulo 1 puerta de 240 <i>Back panel for 1-door module 240</i>	48,6 x 232 x 0,6  0,007   1 u	<b>9</b>	<b>10</b>	<b>11</b>	<b>12</b>
 <b>EL044</b>	Techo módulo 1 puerta para altura 200 y 240 <i>Top panel for 1-door module for heights 200 and 240</i>	36 x 46 x 5  0,008   1 u	<b>10</b>	<b>11</b>	<b>12</b>	<b>13</b>
 <b>EL045</b>	Techo módulo 2 puerta para altura 200 y 240 <i>Top panel for 2-door module for heights 200 and 240</i>	36 x 93 x 5  0,017   1 u	<b>17</b>	<b>19</b>	<b>20</b>	<b>22</b>
 <b>EL046</b>	Divisor módulo 1 puerta para altura 240 <i>Divider panel for 1-door module for height 240</i>	34,3 x 46,6 x 1,9  0,003   1 u	<b>9</b>	<b>10</b>	<b>11</b>	<b>12</b>
 <b>EL047</b>	Divisor módulo 2 puertas para altura 240 <i>Divider panel for 2-door module for height 240</i>	34,3 x 93 x 1,9  0,006   1 u	<b>15</b>	<b>17</b>	<b>18</b>	<b>20</b>

Para altura 240 cm  
con puertas  
Height 240 cm with doors

Ref.	Descripción Description	Medidas cm Measure cm	Puntos Points			
			A	B	C	A la Arena
 <b>EL048</b>	Estante módulo 1 puerta <i>1-door module shelf</i>	30,3 x 46,6 x 1,9  0,003   1 u	<b>8</b>	<b>9</b>	<b>10</b>	<b>11</b>
 <b>EL049</b>	Estante módulo 2 puerta <i>2-door module shelf</i>	30,3 x 93 x 1,9  0,005   1 u	<b>15</b>	<b>16</b>	<b>18</b>	<b>19</b>
 <b>EL050</b>	Base módulo 1 puerta <i>1-door module base</i>	35 x 46,6 x 5  0,008   1 u	<b>12</b>	<b>13</b>	<b>14</b>	<b>15</b>
 <b>EL051</b>	Base módulo 2 puerta <i>2-door module base</i>	35 x 93 x 5  0,017   1 u	<b>21</b>	<b>23</b>	<b>25</b>	<b>27</b>
 <b>EL052</b>	Puerta alta cristal para altura de 160 y 240 <i>High glass door for heights 160 and 240</i>	46,2 x 149,7 x 2,5  0,018   1 u	<b>15</b>	<b>17</b>	<b>18</b>	<b>20</b>
 <b>EL054</b>	Puerta baja cristal para altura de 88 y 240 <i>Low glass door for heights 88 and 240</i>	46,2 x 77,6 x 2,5  0,009   1 u	<b>11</b>	<b>12</b>	<b>13</b>	<b>14</b>
 <b>EL055</b>	Puerta baja madera para altura de 88 y 240 <i>Low wood door for heights 88 and 240</i>	46,2 x 77,6 x 2,5  0,009   1 u	<b>18</b>	<b>20</b>	<b>22</b>	<b>23</b>

Altura 240 cm con puertas alta y baja  
Height 240 cm with upper and lower doors

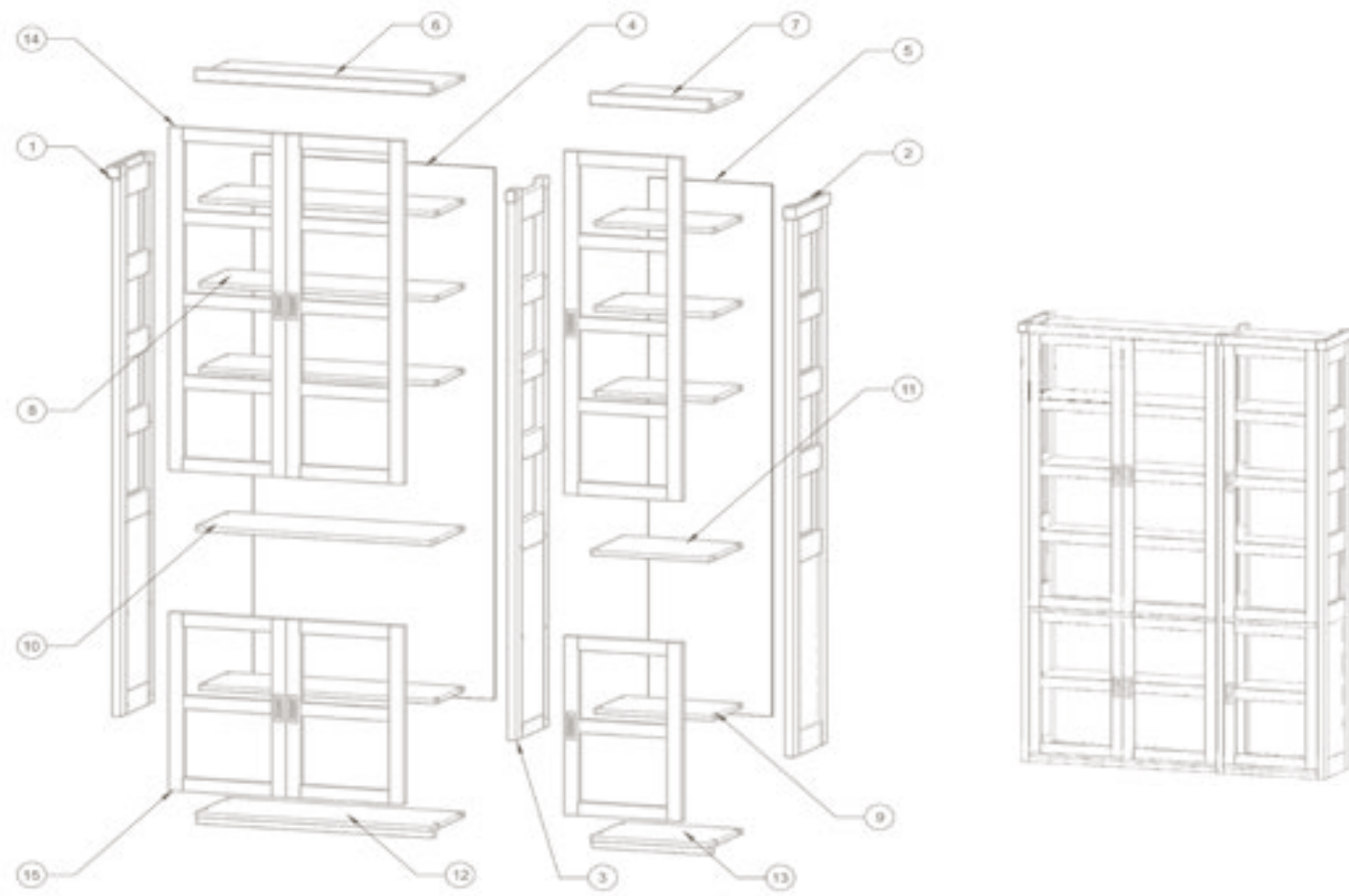

1	EL029 EL032	Costado izquierdo cristal o madera de 240 para puertas alta y baja
2	EL030 EL035	Costado derecho cristal o madera de 240 para puertas alta y baja
3	EL038	Costado central de 240 para puertas
4	EL040	Trasera módulo 2 puertas de 240
5	EL041	Trasera módulo 1 puerta altura 240
6	EL045	Techo módulo 2 puertas altura 200 y 240
7	EL044	Techo módulo 1 puerta altura 200 y 240
8	EL049	Estante módulo 2 puertas, x4 en esta composición

9	EL048	Estante módulo 1 puertas, x4 en esta composición
10	EL047	Divisor módulo 2 puertas altura 240
11	EL046	Divisor módulo 1 puerta altura 240
12	EL051	Base módulo 2 puertas
13	EL050	Base módulo 1 puerta
14	EL052	Puerta cristal alta para altura 160 y 240, x3 en esta composición
15	EL054 EL055	Puerta cristal o madera baja para altura 88 y 240, x3 en esta composición

Altura 240 cm con puerta baja  
Height 240 cm with lower door

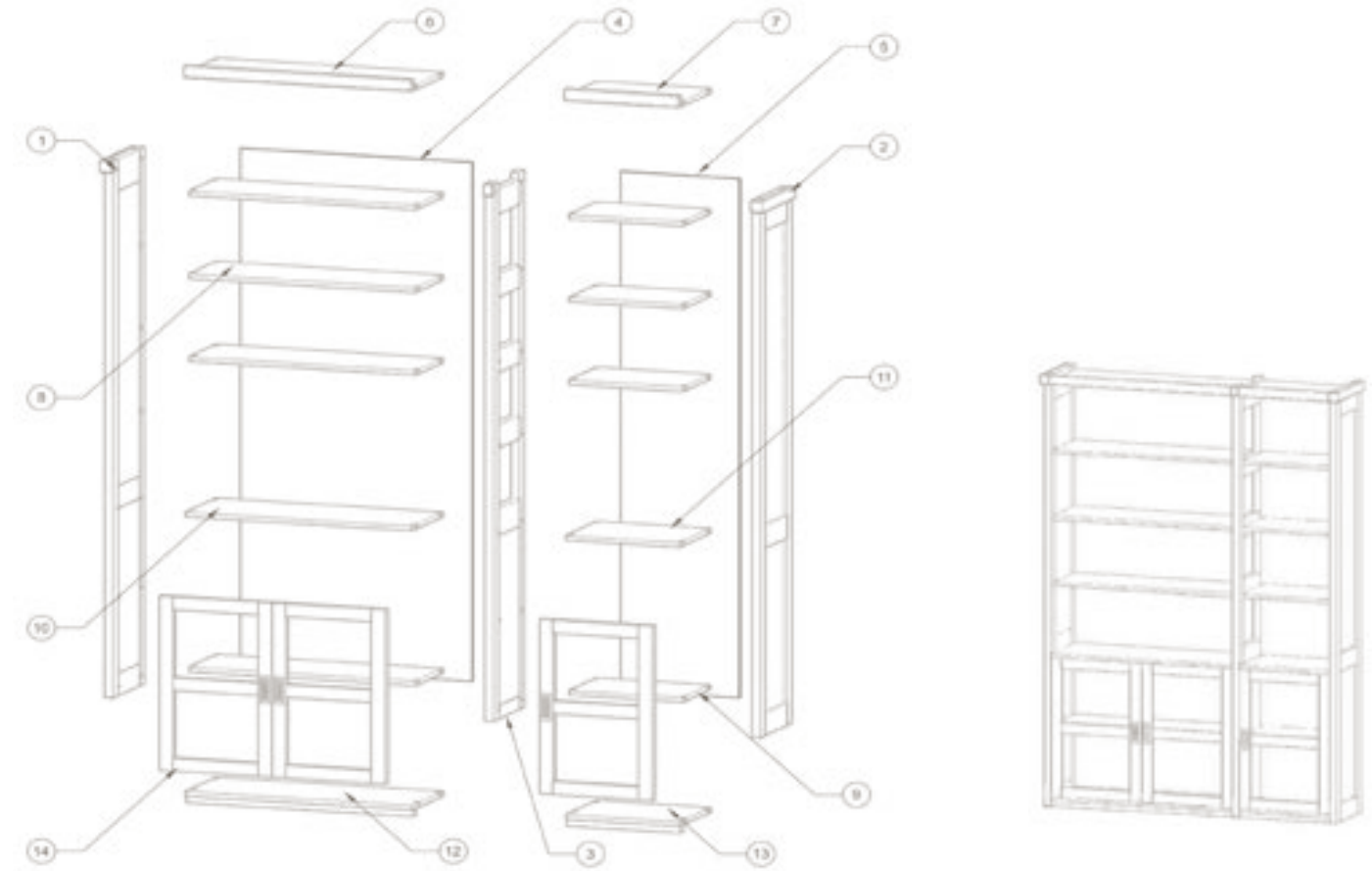

1	EL033	Costado izquierdo madera de 240 para puertas baja
2	EL036	Costado derecho madera de 240 para puerta baja
3	EL039	Costado central de 240 para puerta baja
4	EL040	Trasera módulo 2 puertas de 240
5	EL041	Trasera módulo 1 puerta altura 240
6	EL045	Techo módulo 2 puertas altura 200 y 240
7	EL044	Techo módulo 1 puerta altura 200 y 240
8	EL049	Estante módulo 2 puertas, x4 en esta composición































9	EL048	Estante módulo 1 puertas, x4 en esta composición
10	EL047	Divisor módulo 2 puertas altura 240
11	EL046	Divisor módulo 1 puerta altura 240
12	EL051	Base módulo 2 puertas
13	EL050	Base módulo 1 puerta
14	EL054 EL055	Puerta cristal o madera baja para altura 88 y 240, x3 en esta composición



Para altura  
88 cm sin puertas  
Height 88 cm without doors

Ref.	Descripción Description	Medidas cm Measure cm	Puntos Points			
			A	B	C	A la Arena
 <b>EL001</b>	Costado izquierdo madera de 88 <i>Left wood side panel 88</i>	35 x 84,9 x 3,2  0,015  1 u	14	16	17	18
 <b>EL003</b>	Costado derecho madera de 88 <i>Right wood side panel 88</i>	35 x 84,9 x 3,2  0,015  1 u	14	16	17	18
 <b>EL005</b>	Costado central madera de 88 <i>Central wood side panel 88</i>	35 x 84,9 x 3,2  0,015  1 u	17	18	20	21
 <b>EL007</b>	Trasera módulo 2 puertas de 88 <i>Back panel for 2-door module 88</i>	95 x 80 x 0,6  0,005  1 u	6	7	8	9
 <b>EL008</b>	Trasera módulo 1 puerta de 88 <i>Back panel for 1-door module 88</i>	48,6 x 80 x 0,6  0,002  1 u	3	4	5	6
 <b>EL042</b>	Techo módulo 1 puerta para altura 88 y 160 <i>Top panel for 1-door module for heights 88 and 160</i>	34,3 x 46,6 x 1,9  0,003  1 u	9	10	11	12
 <b>EL043</b>	Techo módulo 2 puerta para altura 88 y 160 <i>Top panel for 2-door module for heights 88 and 160</i>	34,3 x 93 x 1,9  0,006  1 u	15	17	18	20

Para altura  
88 cm sin puertas  
Height 88 cm without doors

Ref.	Descripción Description	Medidas cm Measure cm	Puntos Points			
			A	B	C	A la Arena
 <b>EL048</b>	Estante módulo 1 puerta <i>1-door module shelf</i>	30,3 x 46,6 x 1,9  0,003  1 u	8	9	10	11
 <b>EL049</b>	Estante módulo 2 puerta <i>2-door module shelf</i>	30,3 x 93 x 1,9  0,005  1 u	15	16	18	19
 <b>EL050</b>	Base módulo 1 puerta <i>1-door module base</i>	35 x 46,6 x 5  0,008  1 u	12	13	14	15
 <b>EL051</b>	Base módulo 2 puerta <i>2-door module base</i>	35 x 93 x 5  0,017  1 u	21	23	25	27
 <b>EL056</b>	Tapa 1 módulo de 1 puerta para altura 88 y 160 <i>Top panel for 1-door module for heights 88 and 160</i>	56 x 38 x 3  0,007  1 u	11	12	13	14
 <b>EL057</b>	Tapa 1 módulo de 2 puertas para altura 88 y 160 <i>Top panel for 2-door module for heights 88 and 160</i>	105 x 39 x 3  0,013  1 u	19	20	22	24
 <b>EL058</b>	Tapa 1 módulo de 1 puerta y 1 de 2 puertas para altura de 88 y 160 <i>Top panel for 1-door module plus 2-door module for heights 88 and 160</i>	152 x 38 x 3  0,018  1 u	26	29	31	33
 <b>EL059</b>	Tapa 2 módulos de 2 puertas para altura de 88 y 160 <i>Top panel for 2-door double module for heights 88 and 160</i>	198 x 38 x 3  0,023  1 u	33	37	40	43
 <b>EL060</b>	Tapa 1 módulo de 1 puerta y 2 de 2 puertas para altura 88 y 160 <i>Top panel for 1-door module plus 2-door double module for heights 88 and 160</i>	248 x 38 x 3  0,029  1 u	53	58	62	67
 <b>EL061</b>	Tapa 3 módulos de 2 puertas para altura de 88 y 160 <i>Top panel for 3-door double module for heights 88 and 160</i>	295 x 38 x 3  0,034  1 u	62	68	73	79

Para altura  
88 cm sin puertas  
Height 88 cm without doors

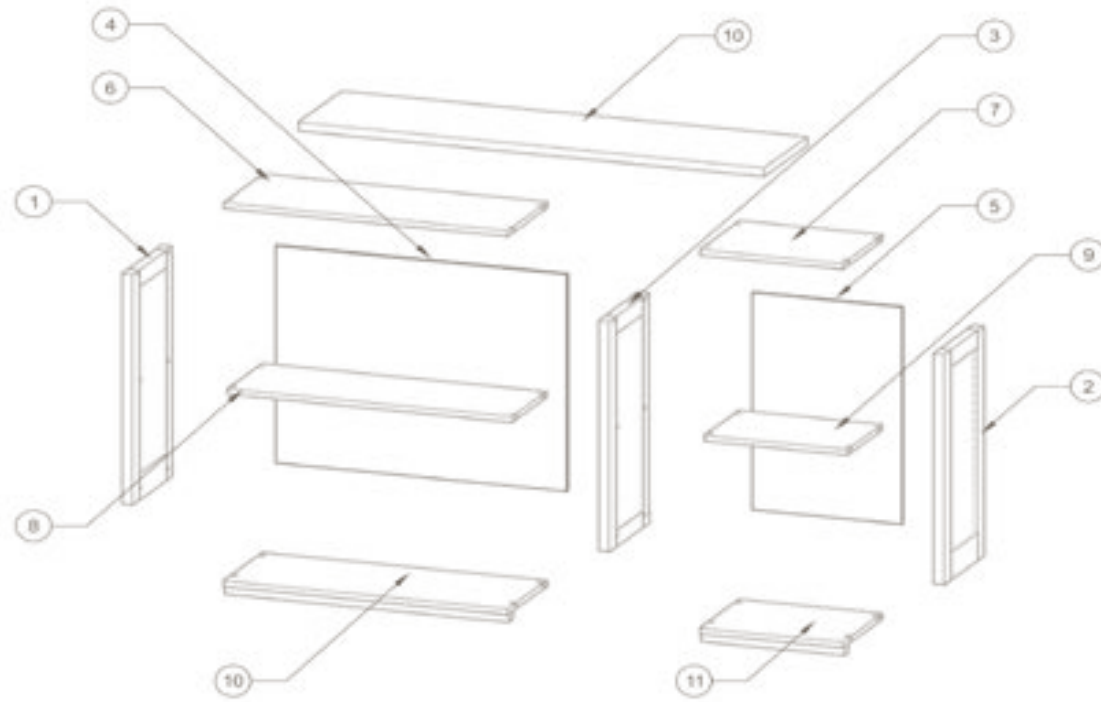

1	EL001	Costado izquierdo de 88
2	EL003	Costado derecho de 88
3	EL005	Costado central de 88
4	EL007	Trasera módulo 2 puertas altura 88
5	EL008	Trasera módulo 1 puerta altura 88
6	EL043	Techo módulo 2 puertas altura 88 y 160



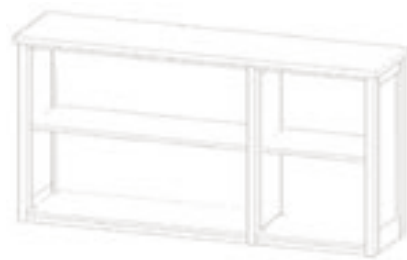

























7	EL042	Techo módulo 1 puertas altura 88 y 160
8	EL049	Estante módulo 2 puertas
9	EL048	Estante módulo 1 puerta
10	EL051	Base módulo 2 puertas
11	EL050	Base módulo 1 puerta
12	EL058	Tapa para altura 88 y 160, largo según número de módulos

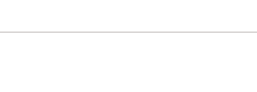

Para altura  
160 cm sin puertas  
Height 160 cm without doors

		Ref.	Descripción Description	Medidas cm Measure cm	Puntos Points			
					A	B	C	A la Arena
	<b>EL011</b>		Costado izquierdo madera de 160 <i>Left wood side panel 160</i>	35 x 157 x 3,2  0,020 m <sup>2</sup> 1 u	<b>24</b>	<b>26</b>	<b>28</b>	<b>30</b>
	<b>EL013</b>		Costado derecho madera de 160 <i>Right wood side panel 160</i>	35 x 157 x 3,2  0,020 m <sup>2</sup> 1 u	<b>24</b>	<b>26</b>	<b>28</b>	<b>30</b>
	<b>EL015</b>		Costado central de 160 <i>Central wood side panel 160</i>	35 x 157 x 3,2  0,020 m <sup>2</sup> 1 u	<b>15</b>	<b>17</b>	<b>18</b>	<b>20</b>
	<b>EL017</b>		Trasera módulo 2 puertas de 160 <i>Back panel for 2-door module 160</i>	95 x 152,1 x 0,6  0,009 m <sup>2</sup> 1 u	<b>12</b>	<b>13</b>	<b>14</b>	<b>15</b>
	<b>EL018</b>		Trasera módulo 1 puerta de 160 <i>Back panel for 1-door module 160</i>	48,6 x 152,1 x 0,6  0,005 m <sup>2</sup> 1 u	<b>6</b>	<b>7</b>	<b>8</b>	<b>9</b>
	<b>EL042</b>		Techo módulo 1 puerta para altura 88 y 160 <i>Top panel for 1-door module for heights 88 and 160</i>	34,3 x 46,6 x 1,9  0,003 m <sup>2</sup> 1 u	<b>4</b>	<b>5</b>	<b>6</b>	<b>7</b>
	<b>EL043</b>		Techo módulo 2 puerta para altura 88 y 160 <i>Top panel for 2-door module for heights 88 and 160</i>	34,3 x 93 x 1,9  0,006 m <sup>2</sup> 1 u	<b>5</b>	<b>6</b>	<b>7</b>	<b>8</b>

Para altura  
160 cm sin puertas  
Height 160 cm without doors

Ref.	Descripción Description	Medidas cm Measure cm	Puntos Points			A la Arena
			A	B	C	
 <b>EL048</b>	Estante módulo 1 puerta 1-door module shelf	30,3 x 46,6 x 1,9  0,003  1 u	8	9	10	11
 <b>EL049</b>	Estante módulo 2 puerta 2-door module shelf	30,3 x 93 x 1,9  0,005  1 u	15	16	18	19
 <b>EL050</b>	Base módulo 1 puerta 1-door module base	35 x 46,6 x 5  0,008  1 u	12	13	14	15
 <b>EL051</b>	Base módulo 2 puertas 2-door module base	35 x 93 x 5  0,017  1 u	21	23	25	27
 <b>EL056</b>	Tapa 1 módulo de 1 puerta para altura 88 y 160 Top panel for 1-door module for heights 88 and 160	56 x 38 x 3  0,007  1 u	11	12	13	14
 <b>EL057</b>	Tapa 1 módulo de 2 puertas para altura 88 y 160 Top panel for 2-door module for heights 88 and 160	105 x 39 x 3  0,013  1 u	19	20	22	24
 <b>EL058</b>	Tapa 1 módulo de 1 puerta y 1 de 2 puertas para altura de 88 y 160 Top panel for 1-door module plus 2-door module for heights 88 and 160	152 x 38 x 3  0,018  1 u	26	29	31	33
 <b>EL059</b>	Tapa 2 módulos de 2 puertas para altura de 88 y 160 Top panel for 2-door double module for heights 88 and 160	198 x 38 x 3  0,023  1 u	33	37	40	43
 <b>EL060</b>	Tapa 1 módulo de 1 puerta y 2 de 2 puertas para altura 88 y 160 Top panel for 1-door module plus 2-door double mod	248 x 38 x 3  0,029  1 u	53	58	62	67
 <b>EL061</b>	Tapa 3 módulos de 2 puertas para altura de 88 y 160 Top panel for 3-door double module for heights 88 and 160	295 x 38 x 3  0,034  1 u	62	68	73	79

Para altura  
160 cm sin puertas  
Height 160 cm without doors

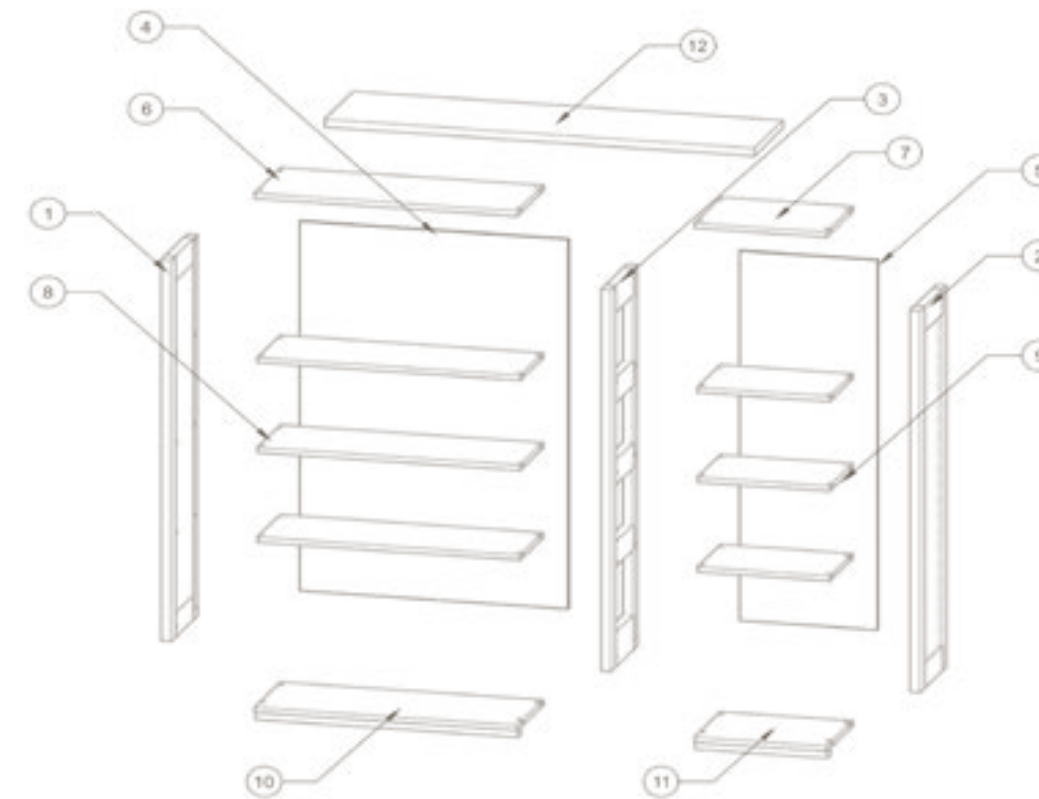

































1	<b>EL011</b>	Costado izquierdo madera de 160
2	<b>EL013</b>	Costado derecho madera de 160
3	<b>EL015</b>	Costado central de 88
4	<b>EL017</b>	Trasera módulo 2 puertas altura 88
5	<b>EL018</b>	Trasera módulo 1 puerta altura 88
6	<b>EL043</b>	Techo módulo 2 puertas altura 88 y 160

7	<b>EL042</b>	Techo módulo 1 puertas altura 88 y 160
8	<b>EL049</b>	Estante módulo 2 puertas
9	<b>EL048</b>	Estante módulo 1 puerta
10	<b>EL051</b>	Base módulo 2 puertas
11	<b>EL050</b>	Base módulo 1 puerta
12	<b>EL058</b>	Tapa para altura 88 y 160, largo según número de módulos



Para altura  
200 cm sin puertas  
Height 200 cm without doors

Ref.	Descripción Description	Medidas cm Measure cm	Puntos Points			A la Arena
			A	B	C	
 <b>EL021</b>	Costado izquierdo madera de 200 <i>Left wood side panel 200</i>	36,5 x 201 x 4,7  0,035  1 u	26	28	30	33
 <b>EL023</b>	Costado derecho madera de 200 <i>Right wood side panel 200</i>	36,5 x 201 x 4,7  0,035  1 u	26	28	30	33
 <b>EL025</b>	Costado central de 200 <i>Central wood side panel 200</i>	36,5 x 201 x 4,7  0,035  1 u	32	35	38	40
 <b>EL027</b>	Trasera módulo 2 puertas de 200 <i>Back panel for 2-door module 200</i>	95 x 192 x 0,6  0,011  1 u	14	16	17	18
 <b>EL028</b>	Trasera módulo 1 puerta de 200 <i>Back panel for 1-door module 200</i>	48,6 x 192 x 0,6  0,003  1 u	7	8	9	10
 <b>EL044</b>	Techo módulo 1 puerta para altura 200 y 240 <i>Top panel for 1-door module for heights 200 and 240</i>	36 x 46 x 5  0,006  1 u	10	11	12	13
 <b>EL045</b>	Techo módulo 2 puerta para altura 200 y 240 <i>Top panel for 2-door module for heights 200 and 240</i>	36 x 93 x 5  0,017  1 u	17	19	20	22
 <b>EL048</b>	Estante módulo 1 puerta <i>1-door module shelf</i>	30,3 x 46,6 x 1,9  0,003  1 u	8	9	10	11
 <b>EL049</b>	Estante módulo 2 puerta <i>2-door module shelf</i>	30,3 x 93 x 1,9  0,005  1 u	15	16	18	19
 <b>EL050</b>	Base módulo 1 puerta <i>1-door module base</i>	35 x 46,6 x 5  0,008  1 u	12	13	14	15
 <b>EL051</b>	Base módulo 2 puertas <i>2-door module base</i>	35 x 93 x 5  0,017  1 u	21	23	25	27

Para altura  
200 cm sin puertas  
Height 200 cm without doors

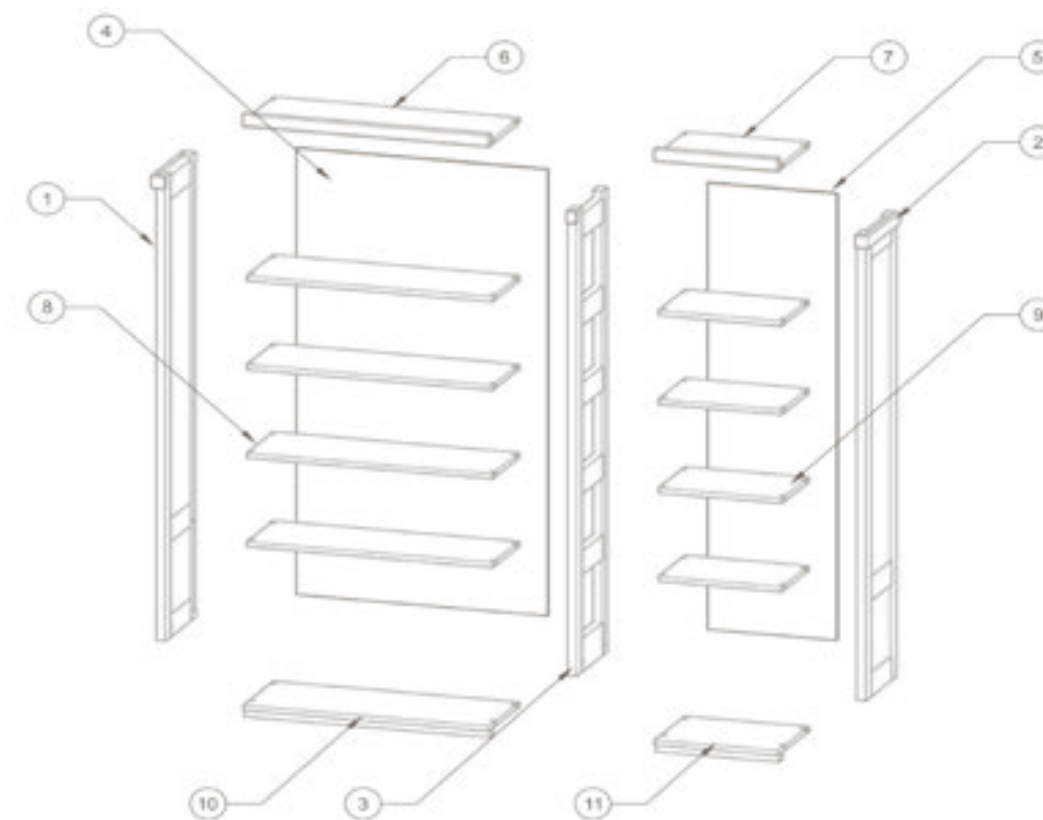



















1	<b>EL021</b>	Costado izquierdo madera de 200
2	<b>EL023</b>	Costado derecho madera de 200
3	<b>EL025</b>	Costado central de 200
4	<b>EL027</b>	Trasera módulo 2 puertas altura 200
5	<b>EL028</b>	Trasera módulo 1 puerta altura 200
6	<b>EL045</b>	Techo módulo 2 puertas altura 200 y 240





















7	<b>EL044</b>	Techo módulo 1 puertas altura 200 y 240
8	<b>EL049</b>	Estante módulo 2 puertas, x4 en esta composición
9	<b>EL048</b>	Estante módulo 1 puertas, x4 en esta composición
10	<b>EL051</b>	Base módulo 2 puertas
11	<b>EL050</b>	Base módulo 1 puerta



Para altura  
240 cm sin puertas  
Height 240 cm without doors

Ref.	Descripción Description	Medidas cm Measure cm	Puntos Points			
			A	B	C	A la Arena
 <b>EL031</b>	Costado izquierdo madera de 240 <i>Left wood side panel 240</i>	36,5 x 240 x 4,7  0,042  1 u	29	32	35	37
 <b>EL034</b>	Costado derecho madera de 240 <i>Right wood side panel 240</i>	36,5 x 240 x 4,7  0,042  1 u				
 <b>EL037</b>	Costado central de 240 <i>Central wood side panel 240</i>	36,5 x 240 x 4,7  0,042  1 u	36	40	43	46
 <b>EL040</b>	Trasera módulo 2 puertas de 240 <i>Back panel for 2-door module 240</i>	95 x 232 x 0,6  0,013  1 u				
 <b>EL041</b>	Trasera módulo 1 puerta de 240 <i>Back panel for 1-door module 240</i>	48,6 x 232 x 0,6  0,007  1 u	9	10	11	12
 <b>EL044</b>	Techo módulo 1 puerta para altura 200 y 240 <i>Top panel for 1-door module for heights 200 and 240</i>	36 x 46 x 5  0,008  1 u				

Para altura  
240 cm sin puertas  
Height 240 cm without doors

Ref.	Descripción Description	Medidas cm Measure cm	Puntos Points			
			A	B	C	A la Arena
 <b>EL045</b>	Techo módulo 2 puerta para altura 200 y 240 <i>Top panel for 2-door module for heights 200 and 240</i>	36 x 93 x 5  0,017  1 u	17	19	20	22
 <b>EL046</b>	Divisor módulo 1 puerta para altura 240 <i>Divider panel for 1-door module for height 240</i>	34,3 x 46,6 x 1,9  0,003  1 u				
 <b>EL047</b>	Divisor módulo 2 puertas para altura 240 <i>Divider panel for 2-door module for height 240</i>	34,3 x 93 x 1,9  0,006  1 u	15	17	18	20
 <b>EL048</b>	Estante módulo 1 puerta <i>1-door module shelf</i>	30,3 x 46,6 x 1,9  0,003  1 u				
 <b>EL049</b>	Estante módulo 2 puerta <i>2-door module shelf</i>	30,3 x 93 x 1,9  0,005  1 u	15	16	18	19
 <b>EL050</b>	Base módulo 1 puerta <i>1-door module base</i>	35 x 46,6 x 5  0,008  1 u				
 <b>EL051</b>	Base módulo 2 puerta <i>2-door module base</i>	35 x 93 x 5  0,017  1 u	21	23	25	27

Para altura  
240 cm sin puertas  
Height 240 cm without doors

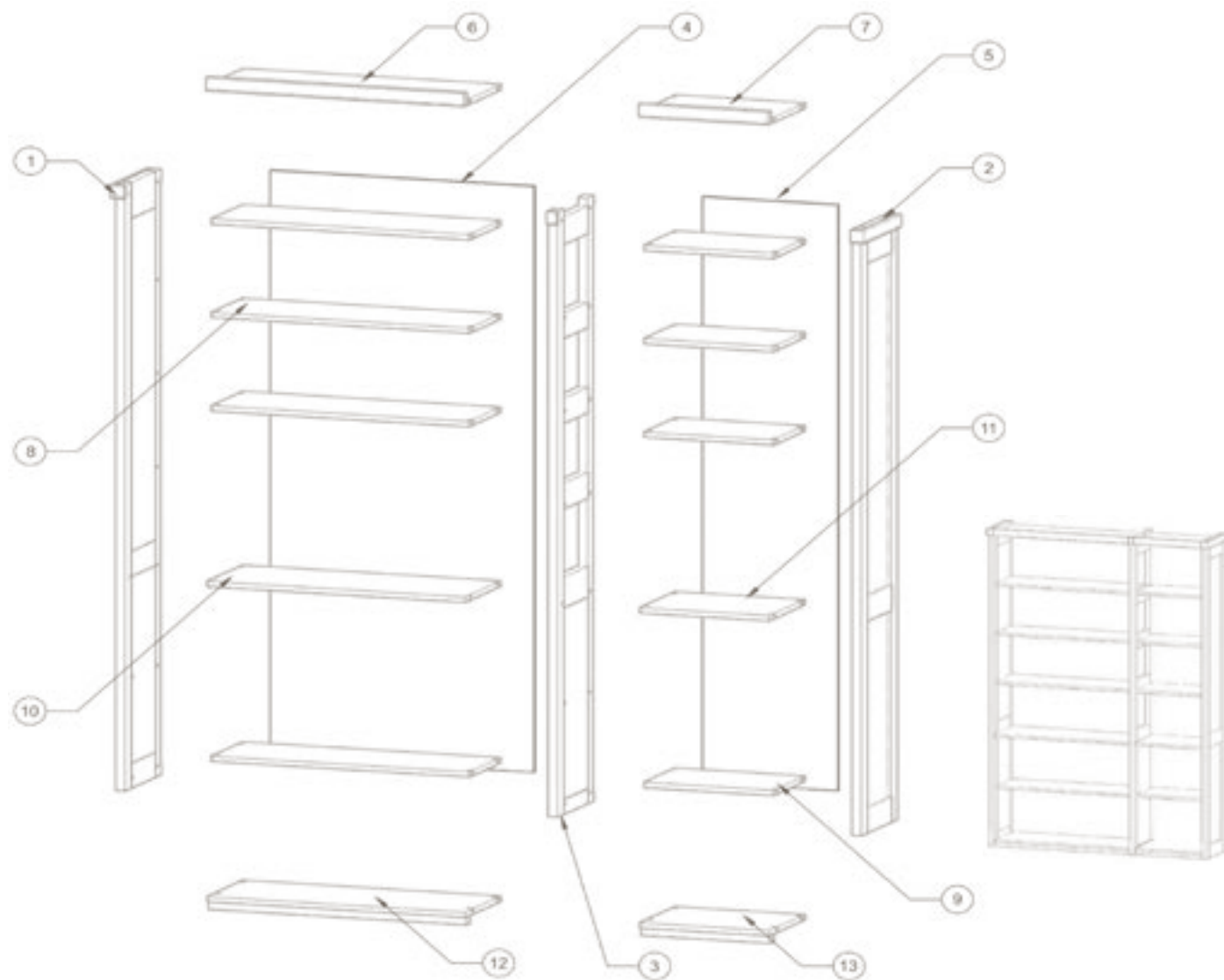

1	EL031	Costado izquierdo madera de 240
2	EL034	Costado derecho madera de 240
3	EL037	Costado central de 240
4	EL040	Trasera módulo 2 puertas altura 240
5	EL041	Trasera módulo 1 puerta altura 240
6	EL045	Techo módulo 2 puertas altura 200 y 240









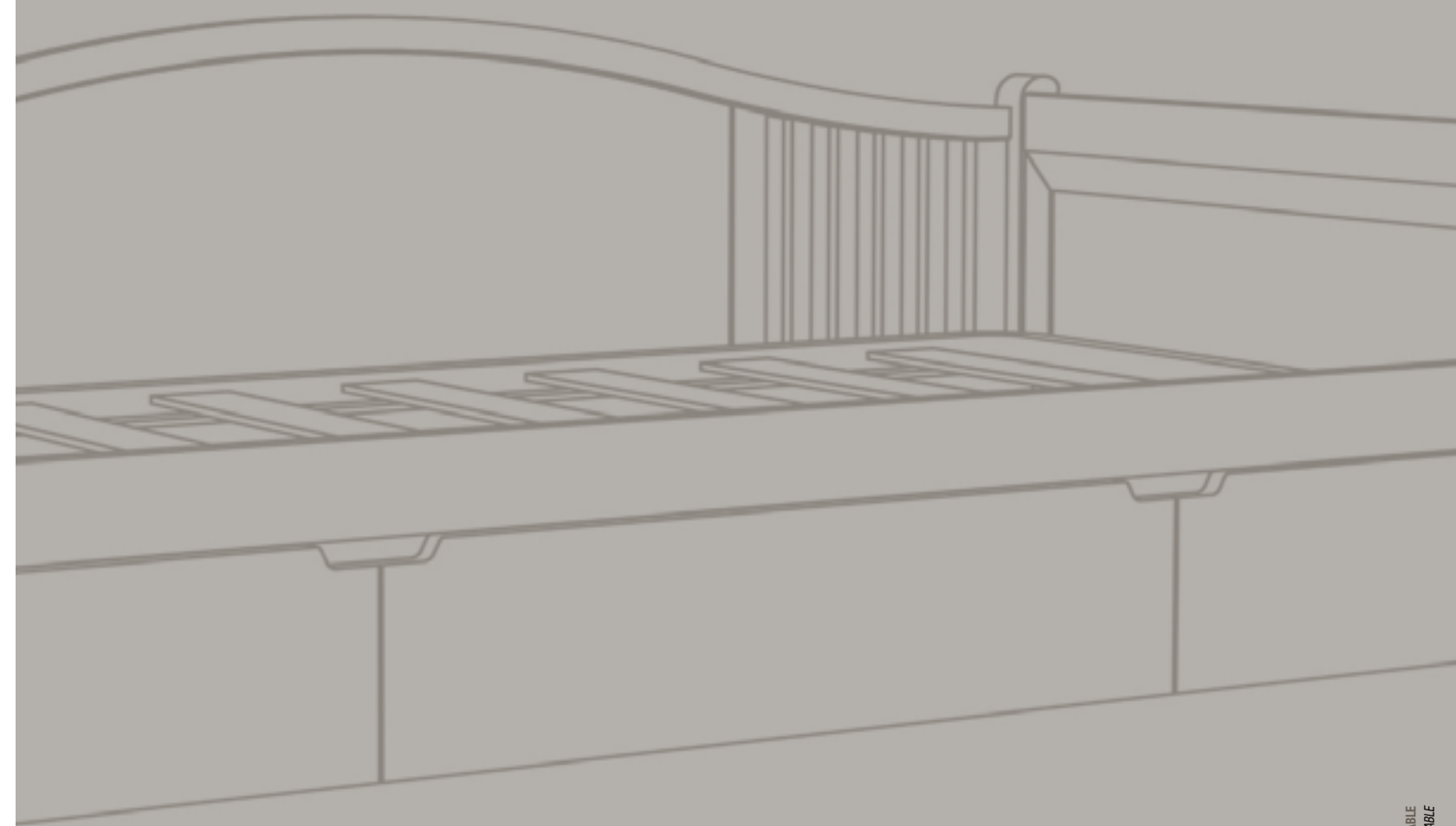









7	EL044	Techo módulo 1 puertas altura 200 y 240
8	EL049	Estante módulo 2 puertas, x4 en esta composición
9	EL048	Estante módulo 1 puerta, x4 en esta composición
10	EL047	Divisor módulo 2 puertas altura 240
11	EL046	Divisor módulo 1 puertas altura 240
12	EL051	Base módulo 2 puertas
13	EL050	Base módulo 1 puerta

# JUVENIL APILABLES







## APILABLE NESTABLE

DORMITORIOS  
BEDROOMS

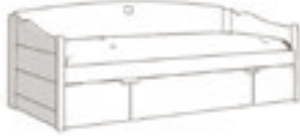

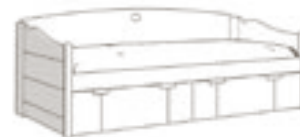

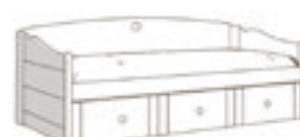





Arcones Modules	Ref.	Descripción Description	Medidas cm Measure cm	Puntos Points			
				A	B	C	A la Arena
	<b>3001</b>	Módulo arcón con apertura frontal (sin tapa) <i>Module with opening front (without top)</i>	100 x 74 x 47'5  0,364   1 u	<b>76</b>	<b>84</b>	<b>89</b>	<b>95</b>
	<b>3002</b>	Módulo arcón con apertura frontal con reducción de fondo (sin tapa) <i>Module with opening front &amp; reduced depth (without top)</i>	100 x 74 x ____  0,642   1 u	<b>83</b>	<b>92</b>	<b>98</b>	<b>105</b>
	<b>3003</b>	Módulo arcón con apertura frontal y superior <i>Module with opening front &amp; top</i>	100 x 77 x 47'5  0,378   1 u	<b>101</b>	<b>111</b>	<b>119</b>	<b>127</b>
	<b>3004</b>	Módulo arcón con apertura frontal y superior con reducción de fondo <i>Module with opening front &amp; top with reduced depth</i>	100 x 77 x ____  0,642   1 u	<b>111</b>	<b>122</b>	<b>131</b>	<b>140</b>
	<b>3005</b>	Módulo arcón zapatero (sin tapa) <i>Storage shoe module (without top)</i>	100 x 74 x 47'5  0,364   1 u	<b>112</b>	<b>123</b>	<b>132</b>	<b>141</b>
	<b>3006</b>	Módulo arcón zapatero con reducción de fondo (sin tapa) <i>Storage shoe module with reduced depth (without top)</i>	100 x 74 x ____  0,642   1 u	<b>123</b>	<b>136</b>	<b>145</b>	<b>155</b>









NOTA: Pueden hacerse arcones de 115 (para camas de 105) con 30% de incremento.  
 Note: We may manufacture modules of 115 (for bed of 105) with an increase of 30%.

Sofá nido Danae Sofa trundle bed Danae	Ref.	Descripción Description	Medidas cm Measure cm	Puntos Points			
				A	B	C	A la Arena
	<b>7001</b>	Sofá nido Danae con arrastre <i>Sofa trundle bed Danae</i>	206 x 67 x 100  0,400   3 u	<b>241</b>	<b>268</b>	<b>286</b>	<b>306</b>
	<b>7002</b>	Sofá nido Danae con 2 cajones <i>Sofa trundle bed Danae with 2 drawers</i>	206 x 67 x 100  0,642   5 u	<b>310</b>	<b>344</b>	<b>368</b>	<b>394</b>
	<b>7003</b>	Sofá nido Danae con 3 cajones <i>Sofa trundle bed Danae with 3 drawers</i>	206 x 67 x 100  0,513   4 u	<b>352</b>	<b>391</b>	<b>418</b>	<b>447</b>









  

Sofá nido Besora Sofa trundle bed Besora	Ref.	Descripción Description	Medidas cm Measure cm	Puntos Points			
				A	B	C	A la Arena
	<b>BD01</b>	Sofá nido Besora con arrastre <i>Sofa trundle bed Besora</i>	207 x 83 x 101  0,400   3 u	<b>212</b>	<b>233</b>	<b>252</b>	<b>270</b>
	<b>BD02</b>	Sofá nido Besora con 2 cajones <i>Sofa trundle bed Besora with 2 drawers</i>	207 x 83 x 101  0,642   5 u	<b>292</b>	<b>321</b>	<b>346</b>	<b>371</b>
	<b>BD03</b>	Sofá nido Besora con 3 cajones <i>Sofa trundle bed Besora with 3 drawers</i>	207 x 83 x 101  0,513   4 u	<b>290</b>	<b>319</b>	<b>344</b>	<b>368</b>













**Sofá nido Delia** Ref.  
*Sofa trundle bed Delia*

	Descripción <i>Description</i>	Medidas cm <i>Measure cm</i>	Puntos <i>Points</i>			
			A	B	C	A la Arena
 <b>DD01</b>	Sofá nido Delia con arrastre <i>Sofa trundle bed Delia</i>	201 x 72 x 100  0,400  3 u 	<b>203</b>	<b>224</b>	<b>241</b>	<b>258</b>
 <b>DD02</b>	Sofá nido Delia con 2 cajones <i>Sofá trundle bed Delia with drawers</i>	201 x 72 x 100  0,642  5 u 	<b>283</b>	<b>311</b>	<b>336</b>	<b>359</b>
 <b>DD03</b>	Sofá nido Delia con 3 cajones <i>Sofa trundle bed Delia with 3 drawers</i>	201 x 72 x 100  0,513  4 u 	<b>281</b>	<b>310</b>	<b>334</b>	<b>358</b>

**Cama nido Besora** Ref.  
*Trundle bed Besora*

	Descripción <i>Description</i>	Medidas cm <i>Measure cm</i>	Puntos <i>Points</i>			
			A	B	C	A la Arena
 <b>3007</b>	Cama nido Besora <i>Trundle bed Besora</i>	206 x 60 x 100  0,316  3 u 	<b>149</b>	<b>165</b>	<b>177</b>	<b>189</b>
 <b>3009</b>	Cama nido Besora 2 cajones <i>Trundle bed Besora with 2 drawers</i>	206 x 60 x 100  0,606  5 u 	<b>218</b>	<b>242</b>	<b>259</b>	<b>277</b>
 <b>7004</b>	Cama nido Besora con 3 cajones <i>Trundle bed Besora with 3 drawers</i>	206 x 60 x 100  0,484  4 u 	<b>259</b>	<b>287</b>	<b>308</b>	<b>330</b>





















**Cama nido Besora** Ref.  
*Trundle bed Besora*







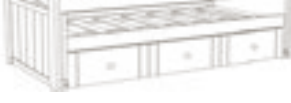











	Descripción <i>Description</i>	Medidas cm <i>Measure cm</i>	Puntos <i>Points</i>			
			A	B	C	A la Arena
 <b>3008</b>	Cama nido Besora para arcón con apertura frontal <i>Trundle bed Besora for opening front storage module</i>	203 x 60 x 100  0,304  3 u 	<b>144</b>	<b>160</b>	<b>171</b>	<b>183</b>
 <b>3010</b>	Cama nido Besora con 2 cajones para arcón con apertura frontal <i>Trundle bed Besora with 2 drawers for opening front storage module</i>	203 x 60 x 100  0,594  5 u 	<b>213</b>	<b>236</b>	<b>253</b>	<b>271</b>
 <b>7005</b>	Cama nido Besora con 3 cajones para arcón con apertura frontal <i>Trundle bed Besora with 3 drawers for opening front storage module</i>	203 x 60 x 100  0,472  4 u 	<b>254</b>	<b>282</b>	<b>302</b>	<b>323</b>
 <b>3033</b>	Panel lateral cama de 210 <i>Lateral wall panel for trundle bed</i>	210 x 53 x 2,3  0,034  1 u 	<b>70</b>	<b>77</b>	<b>83</b>	<b>89</b>







**Cama nido Delia** Ref.  
*Trundle bed Delia*





















	Descripción <i>Description</i>	Medidas cm <i>Measure cm</i>	Puntos <i>Points</i>			
			A	B	C	A la Arena
 <b>7006</b>	Cama nido Delia <i>Trundle bed Delia</i>	203 x 55 x 100  0,310  3 u 	<b>149</b>	<b>165</b>	<b>177</b>	<b>189</b>
 <b>7007</b>	Cama nido Delia con 2 cajones <i>Trundle bed Delia with 2 drawers</i>	203 x 55 x 100  0,591  5 u 	<b>218</b>	<b>242</b>	<b>259</b>	<b>277</b>

































Cama nido Delia Trundle bed Delia		Ref.	Descripción Description	Medidas cm Measure cm	Puntos Points			
					A	B	C	A la Arena
	<b>7008</b>	Cama nido Delia con 3 cajones <i>Trundle bed Delia with 3 drawers</i>	203 x 55 x 100  0,411  4 u	<b>259</b>	<b>287</b>	<b>308</b>	<b>330</b>	
	<b>7009</b>	Cama nido Delia para arcón con apertura frontal <i>Trundle bed Delia for opening front storage module.</i>	203 x 55 x 100  0,213  3 u	<b>144</b>	<b>160</b>	<b>171</b>	<b>183</b>	
	<b>7010</b>	Cama nido Delia con 2 cajones para arcón con apertura frontal <i>Trundle bed Delia with drawers for opening front storage module</i>	203 x 55 x 100  0,591  5 u	<b>213</b>	<b>236</b>	<b>253</b>	<b>271</b>	
	<b>7011</b>	Cama nido Delia con 3 cajones para arcón con apertura frontal <i>Trundle bed Delia with 3 drawers for opening front storage module</i>	203 x 55 x 100  0,462  4 u	<b>254</b>	<b>282</b>	<b>302</b>	<b>323</b>	
	<b>7012</b>	Cama block Delia con 2 camas y 2 cajones bajos <i>Trundle bed block Delia with 2 beds &amp; low drawers</i>	203 x 80 x 100  0,817  6 u	<b>334</b>	<b>371</b>	<b>397</b>	<b>425</b>	
	<b>7013</b>	Cama block Delia con 2 camas y 2 cajones bajos, con frente oculto <i>Trundle bed block Delia with 2 beds &amp; low drawers, with front</i>	203 x 80 x 100  0,746  6 u	<b>359</b>	<b>398</b>	<b>426</b>	<b>456</b>	
	<b>7014</b>	Cama block Delia con 2 camas y 3 cajones bajos <i>Trundle bed block Delia with 2 beds &amp; 3 low drawers</i>	203 x 80 x 100  0,688  5 u	<b>375</b>	<b>416</b>	<b>445</b>	<b>476</b>	

Cama nido Delia Trundle bed Delia		Ref.	Descripción Description	Medidas cm Measure cm	Puntos Points			
					A	B	C	A la Arena
	<b>7015</b>	Cama block Delia con 2 camas y 3 cajones bajos, con frente oculto <i>Trundle bed block Delia with 2 beds &amp; 3 low drawers, with front</i>	203 x 80 x 100  0,617  5 u	<b>400</b>	<b>444</b>	<b>475</b>	<b>508</b>	
	<b>7016</b>	Cama block Delia con 2 camas y 2 cajones bajos, con cabecero de 106 cm. De altura (para arcón zapatero) <i>Trundle bed block Delia with 2 beds, low 2 drawers &amp; high headboard (for storage shoe module)</i>	203 x 106 x 100  0,733  6 u	<b>340</b>	<b>377</b>	<b>403</b>	<b>431</b>	
	<b>7017</b>	Cama block Delia con 2 camas y 2 cajones bajos, con cabecero de 106 cm. de altura (para arcón zapatero), con frente oculto <i>Trundle bed Delia with 2 beds, low 2 drawers &amp; high headboard (for storage shoe module), with front.</i>	203 x 106 x 100  0,765  6 u	<b>365</b>	<b>405</b>	<b>433</b>	<b>463</b>	
	<b>7018</b>	Cama block Delia con 2 camas y 3 cajones bajos, con cabecero de 106 cm. de altura (para arcón zapatero) <i>Trundle bed block Delia with 2 beds, 3 low drawers &amp; high headboard (for storage shoe module)</i>	203 x 106 x 100  0,604  5 u	<b>381</b>	<b>423</b>	<b>452</b>	<b>484</b>	
	<b>7019</b>	Cama block Delia con 2 camas y 3 cajones bajos, con cabecero de 106 cm. de altura (para arcón zapatero), con frente oculto <i>Trundle bed block Delia with 2 beds, 3 low drawers &amp; high headboard (for storage shoe module)</i>	203 x 106 x 100  0,636  5 u	<b>406</b>	<b>451</b>	<b>482</b>	<b>516</b>	
	<b>7020</b>	Cama block Delia con 2 camas y 2 cajones altos <i>Trundle bed block Delia with 2 beds &amp; 2 high drawers</i>	203 x 80 x 100  0,579  4 u	<b>285</b>	<b>316</b>	<b>338</b>	<b>362</b>	

Cama nido Delia Trundle bed Delia		Ref.	Descripción Description	Medidas cm Measure cm	Puntos Points			
					A	B	C	A la Arena
	<b>7023</b>		Cama block Delia con 2 camas y 2 cajones altos, con cabecero de 106 cm. de altura (para arcón zapatero) <i>Trundle bed block Delia with 2 beds, high drawers &amp; high headboard (for storage shoe module)</i>	203 x 106 x 100  0,748  5 u	<b>291</b>	<b>323</b>	<b>346</b>	<b>370</b>
	<b>3033</b>		Panel lateral cama de 210 <i>Lateral wall panel for trundle bed</i>	210 x 53 x 2,3  0,034  1 u	<b>70</b>	<b>77</b>	<b>83</b>	<b>89</b>

Cama nido Bétula Trundle bed Betula		Ref.	Descripción Description	Medidas cm Measure cm	Puntos Points			
					A	B	C	A la Arena
	<b>3022</b>		Cama nido Bétula <i>Trundle bed Betula</i>	203 x 55 x 100  0,294  3 u	<b>149</b>	<b>165</b>	<b>177</b>	<b>189</b>
	<b>3024</b>		Cama nido Bétula con 2 cajones <i>Trundle bed Betula with 2 drawers</i>	203 x 55 x 100  0,584  5 u	<b>218</b>	<b>242</b>	<b>259</b>	<b>277</b>
	<b>7027</b>		Cama nido Bétula con 3 cajones <i>Trundle bed Betula with 3 drawers</i>	203 x 55 x 100  0,455  4 u	<b>259</b>	<b>287</b>	<b>308</b>	<b>330</b>
	<b>3023</b>		Cama nido Bétula para arcón con apertura frontal <i>Trundle bed Betula for opening front storage module</i>	203 x 55 x 100  0,294  3 u	<b>144</b>	<b>160</b>	<b>171</b>	<b>183</b>
	<b>3025</b>		Cama nido Bétula con 2 cajones para arcón con apertura frontal <i>Trundle bed Betula with 2 drawers for opening front storage module</i>	203 x 55 x 100  0,584  5 u	<b>213</b>	<b>236</b>	<b>253</b>	<b>271</b>
	<b>7028</b>		Cama nido Bétula con 3 cajones para arcón con apertura frontal <i>Trundle bed Betula with 3 drawers for opening front storage module</i>	203 x 55 x 100  0,455  4 u	<b>254</b>	<b>282</b>	<b>302</b>	<b>323</b>
	<b>3028</b>		Cama block Bétula con 2 camas y 2 cajones bajos <i>Trundle bed block Betula with 2 beds &amp; low 2 drawers</i>	203 x 80 x 100  0,817  6 u	<b>334</b>	<b>371</b>	<b>397</b>	<b>425</b>









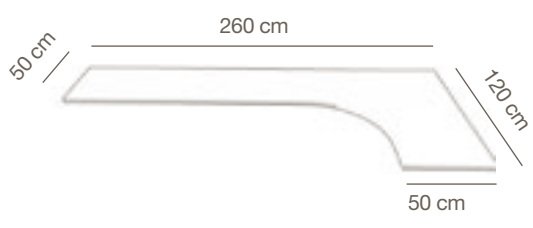

Cama nido Bétula Trundle bed Betula	Ref.	Descripción Description	Medidas cm Measure cm	Puntos Points			
				A	B	C	A la Arena
	7029	Cama block Bétula con 2 camas y 2 cajones bajos, con frente oculto <i>Trundle bed block Betula with 2 beds &amp; low 2 drawers, with front</i>	203 x 80 x 100  0,746  6 u	359	398	426	456
	7030	Cama block Bétula con 2 camas y 3 cajones bajos <i>Trundle bed block Betula with 2 beds &amp; 3 low drawers</i>	203 x 80 x 100  0,688  5 u	375	416	445	476
	7031	Cama block Bétula con 2 camas y 3 cajones bajos, con frente oculto <i>Trundle bed block Betula with 2 beds &amp; 3 low drawers, with front</i>	203 x 80 x 100  0,618  5 u	400	444	475	508
	3029	Cama block Bétula con 2 camas, y 2 cajones bajos y cabecero de 106 cm.de altura (para arcón zapatero) <i>Trundle bed block betula with 2 beds, low 2 drawers &amp; high headboard (for storage shoe module)</i>	203 x 106 x 100  0,733  6 u	340	377	404	432
	7032	Cama block Bétula con 2 camas, 2 cajones bajos y cabecero de 106 cm.de altura (para arcón zapatero), con frente oculto <i>Trundle bed block Betula with 2 beds, low drawers &amp; high headboard (for storage shoe module), with front.</i>	203 x 106 x 100  0,765  6 u	365	405	433	463
	7033	Cama block Bétula con 2 camas, 3 cajones bajos y cabecero de 106 cm.de altura (para arcón zapatero) <i>Trundle bed block Betula with 2 beds, 3 drawers &amp; high headboard (for storage shoe module)</i>	203 x 106 x 100  0,605  5 u	381	423	452	484

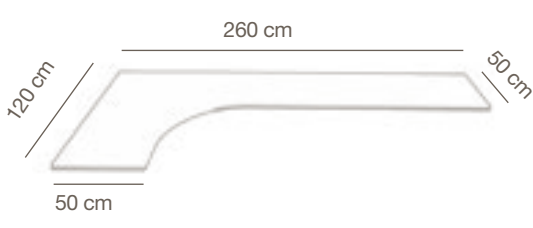
Cama nido Bétula Trundle bed Betula	Ref.	Descripción Description	Medidas cm Measure cm	Puntos Points			
				A	B	C	A la Arena
	7034	Cama block Bétula con 2 camas, 3 cajones bajos y cabecero de 106 cm. de altura (para arcón zapatero), con frente oculto <i>Trundle bed block Betula with 2 beds, 3 drawers &amp; high headboard (for storage shoe module), with front</i>	203 x 106 x 100  0,636  5 u	406	451	482	516
	3030	Cama block Bétula con 2 camas y 2 cajones altos <i>Trundle bed block Betula with 2 beds &amp; high drawers</i>	203 x 80 x 100  0,560  4 u	285	316	338	362
	3031	Cama block Bétula con 2 camas, 2 cajones altos y cabecero de 106 cm. de altura (para arcón zapatero) <i>Trundle bed Betula with 2 beds, high 2 drawers &amp; high headboard (for storage shoe module)</i>	203 x 106 x 100  0,582  4 u	291	323	346	370
	3033	Panel lateral cama de 210 <i>Lateral wall panel for trundle bed</i>	210 x 53 x 2,3  0,034  1 u	70	77	83	89

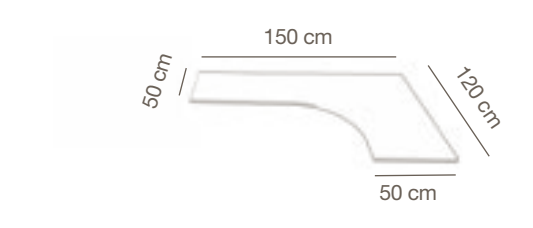
NOTA: Pueden hacerse camas nido de 105 con un 25% de incremento.  
Note: We may manufacture trundle beds of 105 with an increase of 25%.

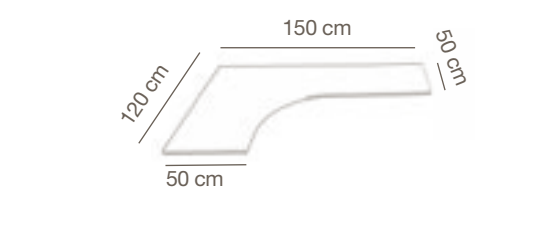

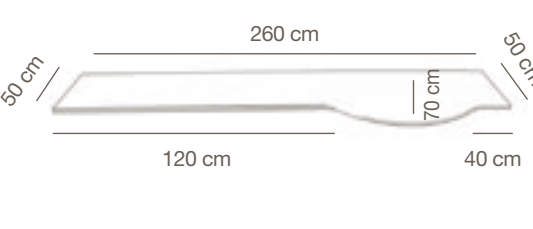



**Encimeras curvas y rectas**

Writing desk (curved & straight)

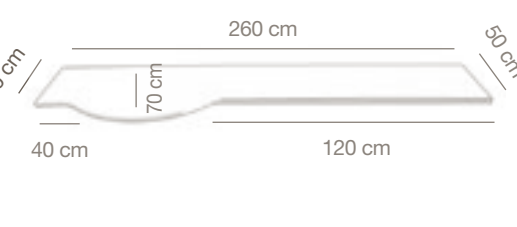
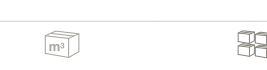
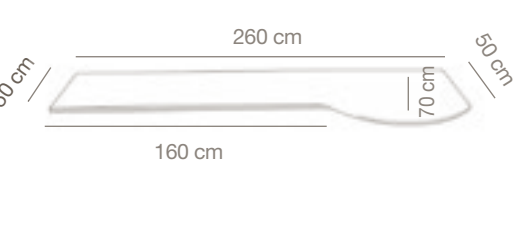
Ref.	Descripción Description	Puntos Points			
		A	B	C	A la Arena
7038	 <p>Encimera rincón derecha 260 x 120 cm (preparada para cortar) <b>Right corner writing desk (prepared to cut)</b></p>	99	110	118	126
	 <p>0,126 1 u</p>				
7039	 <p>Encimera rincón izquierda 260 x 120 cm (preparada para cortar) <b>Left corner writing desk (prepared to cut)</b></p>	99	110	118	126
	 <p>0,126 1 u</p>				
7040	 <p>Encimera rincón derecha 150 x 120 cm (preparada para cortar) <b>Right corner writing desk (prepared to be cut)</b></p>	59	65	70	75
	 <p>0,073 1 u</p>				
7041	 <p>Encimera rincón izquierda 150 x 120 cm (preparada para cortar) <b>Left corner writing desk (prepared to be cut)</b></p>	59	65	70	75
	 <p>0,073 1 u</p>				
3047	 <p>Encimera con forma derecha de 260 (preparada para cortar a dos lados) <b>Right shaped writing desk (prepared to be cut on both sides)</b></p>	64	71	76	81
	 <p>0,073 1 u</p>				

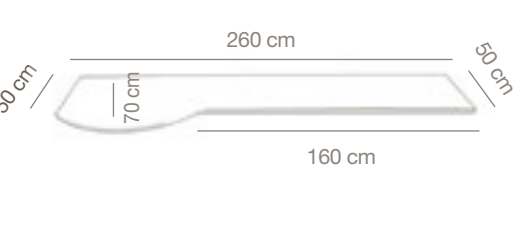

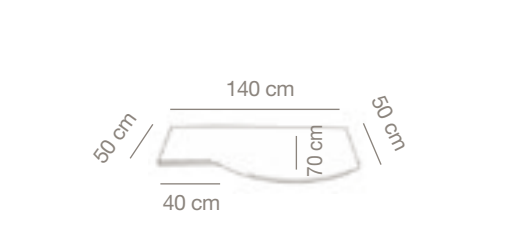
**Encimeras curvas y rectas**

Writing desk (curved & straight)

Ref. Ref. Art.	Descripción Description	Puntos Points Количество пунктов			
		A	B	C	A la Arena
3048	 <p>Encimera con forma izquierda de 260 (preparada para cortar a dos lados) <b>Left shaped writing desk (prepared to be cut on both sides)</b></p>	64	71	76	81
	 <p>0,073 1 u</p>				
3049	 <p>Encimera con forma derecha de 260 (preparada para cortar a un lado) <b>Right shaped writing desk (prepared to be cut on one side)</b></p>	64	71	76	81
	 <p>0,073 1 u</p>				
3050	 <p>Encimera con forma izquierda de 260 (preparada para cortar a un lado) <b>Left shaped writing desk (prepared to be cut on one side)</b></p>	64	71	76	81
	 <p>0,073 1 u</p>				
3051	 <p>Encimera con forma derecha de 140 (preparada para cortar a un lado) <b>Right shaped writing desk (prepared to be cut on one side)</b></p>	40	44	47	50
	 <p>0,042 1 u</p>				



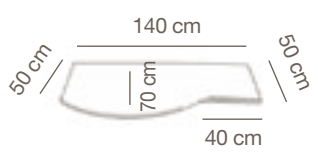
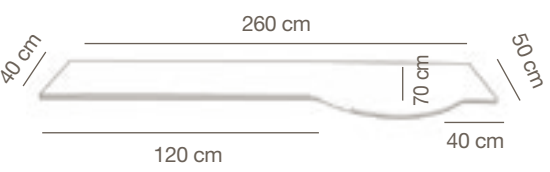
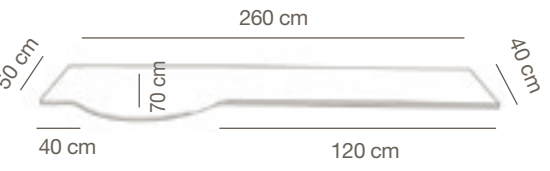
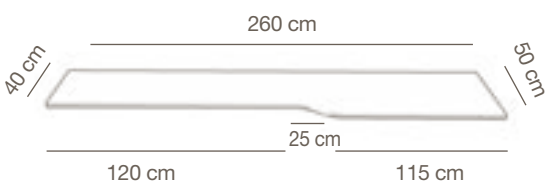
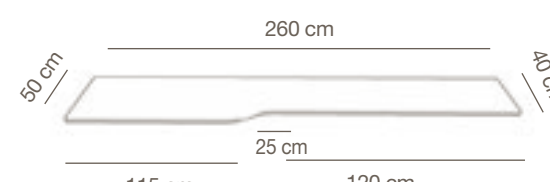



**Encimeras curvas y rectas**

*Writing desk (curved & straight)*

Ref.	Descripción Description	Puntos Points			
		A	B	C	A la Arena
3052	Encimera con forma izquierda de 140 (preparada para cortar a un lado) <i>Left shaped writing desk (prepared to be cut on one side)</i>	40	44	47	50
					
3053	Encimera para reduccion de arcón con forma derecha de 260 (preparada para cortar a dos lados) <i>Right shaped writing desk for module reduction (prepared to be cut on both sides)</i>	64	71	76	81
					
3054	Encimera para reduccion de arcón con forma izquierda de 260 (preparada para cortar a dos lados) <i>Left shaped writing desk for module reduction (prepared to be cut on both sides)</i>	64	71	76	81
					
3055	Encimera para reduccion de arcón recta derecha de 260 (preparada para cortar a dos lados) <i>Right shaped writing desk for module reduction (preparade to be cut on both sides)</i>	64	71	76	81
					
3056	Encimera para reduccion de arcón recta izquierda de 260 (preparada para cortar a dos lados) <i>Left straight shaped writing desk for module reduction (prepared to be cut on both sides)</i>	64	71	76	81
					
3057	Encimera recta de 100 <i>Straight shaped writing desk 100</i>	15	17	18	19
					
3058	Encimera recta de 120 <i>Straight shaped writing desk 120</i>	19	21	23	25
					

**Encimeras curvas y rectas**

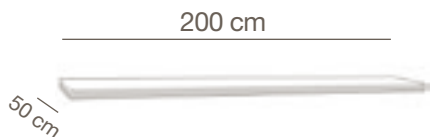
*Writing desk (curved & straight)*

Ref.	Descripción Description	Puntos Points			
		A	B	C	A la Arena
3059	Encimera recta de 140 <i>Straight shaped writing desk 140 cm</i>	22	24	26	28
					
3060	Encimera recta de 150 <i>Straight shaped writing desk 150 cm</i>	23	26	27	29
					
3061	Encimera recta de 160 <i>Straight shaped writing desk 160 cm</i>	25	28	30	32
					
3062	Encimera recta de 180 <i>Straight shaped writing desk 180 cm</i>	27	30	32	34
					
3063	Encimera recta de 200 <i>Straight shaped writing desk 200 cm</i>	30	33	36	39
					
3064	Encimera recta de 210 <i>Straight shaped writing desk 210 cm</i>	31	34	37	40
					
3065	Encimera recta de 240 <i>Straight shaped writing desk 240 cm</i>	36	40	43	46
					











**Encimeras curvas y rectas**  
Writing desk (curved & straight)

Ref.	Descripción Description	Puntos Points			A la Arena
		A	B	C	
3066	Encimera recta de 260 Straight shaped writing desk 260 cm	38	42	45	48
		 0,053	 1 u		

















NOTA: Además de las encimeras ya referenciadas tenemos a su disposición tableros en chapa natural con medida máxima de 320 x 130 para solucionar algún problema puntual que usted precise. Importante enviar plano.  
Todas las encimeras se pueden cortar. Es imprescindible adjuntar en el pedido croquis acotado.  
NOTE: Besides these writing desks we have available natural veneer panels with a maximum size of 320 x 130 to solve any problem.





**COMPLEMENTOS**  
COMPLEMENTS

Ref.	Descripción Description	Medidas cm Measure cm	Puntos Points			A la Arena
			A	B	C	
3034	Soporte metálico para apoyo encimera (solo para cama block con cabecero de 106) Metallic support for writing desk (only for bed block with headboard of 106)	 1 u	8	8	8	8
3036	Cilindro regulable (apoyo encimera)sobre buck Adjustable metallic support (for writing desk)	 1 u	9	9	9	9
3037	Pata cilíndrica apoyo encimera de 74 cm Metallic leg support for writing desk 74cm	 1 u	20	20	20	20
3039	Pie de ala para mesa estudio Support leg for writing desk	16 X 74 x 40  0,024  1 u	17	19	20	21
3040	Pie de ala para mesa estudio rincón Support leg for writing desk	42 x 74 x 42  0,065  1 u	23	25	27	29
7042	Pie de ala Delia Support leg Delia	6 x 74 x 45  0,021  1 u	23	25	27	29
7043	Modulo para CPU CPU module	25 x 65 x 45  0,075  1 u	33	37	39	42



**MÓDULOS BAJOS de 40-fondo 47 base encimera (sin tapa)**  
LOW MODULES of 40- depth 47 writing desk base (without top)

Ref.	Descripción Description	Medidas cm Measure cm	Puntos Points			A la Arena
			A	B	C	
3084	Bajo diáfano de 40 con 1 estante móvil (base encimera) Low module with 1 shelf (writing desk base)	40 x 74 x 45  0,139  1 u	39	43	46	49
3085	Bajo diáfano de 25 con 1 estante móvil (base encimera) Low module with 1 shelf (writing desk base)	25 x 74 x 45  0,087  1 u	29	32	34	36
3086	Bajo 1 puerta de 40 derecha (base encimera) Low module with 1 right door (writing desk base)	40 x 74 x 47	54	60	64	68
3087	Bajo 1 puerta de 40 izquierda (base encimera) Low module with 1 left door (writing desk base)		 0,145  1 u	54	60	64
3088	Bajo 2 cajones y hueco de 40 (base encimera) Low module with 2 drawers & hollow (writing desk base)	40 x 74 x 47  0,145  1 u	67	74	80	86
3089	Bajo con 1 cajón y hueco de 40 (base encimera) Low module with 1 drawer & hollow (writing desk base)	40 x 74 x 47  0,145  1 u	61	68	72	77
3090	Bajo con 3 cajones de 40 (base encimera) Low module with 3 drawers (writing desk base)	40 x 74 x 47  0,145  1 u	85	94	101	108
3092	Bajo con 4 cajones de 40 (base encimera) Low module with 4 drawers (writing desk base)	40 x 74 x 47  0,145  1 u	90	100	107	114

**MÓDULOS BAJOS DE 50 - fondo 47 base encimera (sin tapa)**  
**LOW MODULES of 50 - depth 47 writing desk base (without top)**

Ref.	Descripción Description	Medidas cm Measure cm	Puntos Points			
			A	B	C	A la Arena
 <b>3093</b>	Bajo diáfano de 50 con 1 estante móvil (base encimera) <i>Low module with 1 shelf (writing desk base)</i>	50 x 74 x 45  0,173 m <sup>3</sup> 1 u	<b>43</b>	<b>48</b>	<b>51</b>	<b>55</b>
 <b>3094</b>	Bajo con 1 cajón y hueco de 50 (base encimera) <i>Low module with 1 drawer &amp; hollow (writing desk base)</i>	50 x 74 x 47  0,173 m <sup>3</sup> 1 u	<b>67</b>	<b>74</b>	<b>80</b>	<b>86</b>
 <b>3095</b>	Bajo 2 cajones y hueco de 50 (base encimera) <i>Low module with 2 drawers &amp; hollow (writing desk base)</i>	50 x 74 x 47  0,173 m <sup>3</sup> 1 u	<b>75</b>	<b>83</b>	<b>89</b>	<b>95</b>
 <b>3096</b>	Bajo con 3 cajones de 50 (base encimera) <i>Low module with 3 drawers (writing desk base)</i>	50 x 74 x 47  0,173 m <sup>3</sup> 1 u	<b>95</b>	<b>105</b>	<b>113</b>	<b>121</b>
 <b>3097</b>	Bajo con 4 cajones de 50 (base encimera) <i>Low module with 4 drawers (writing desk base)</i>	50 x 74 x 47  0,173 m <sup>3</sup> 1 u	<b>101</b>	<b>112</b>	<b>120</b>	<b>128</b>







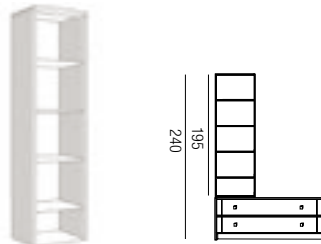
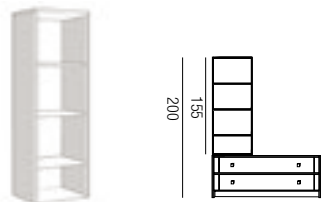





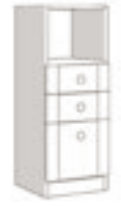

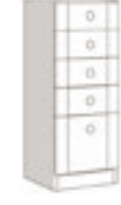

**MódulosBuk fondo 50**  
**Buck modules - depth 50**

Ref.	Descripción Description	Medidas cm Measure cm	Puntos Points			
			A	B	C	A la Arena
 <b>3098</b>	Buck de 50 con 2 cajones (con ruedas) <i>Buck with 2 drawers (with wheels)</i>	50 x 45 x 50  0,117 m <sup>3</sup> 1 u	<b>72</b>	<b>80</b>	<b>86</b>	<b>92</b>
 <b>3099</b>	Buck de 50 con 1 cajón (con ruedas) <i>Buck with 1 drawer (with wheels)</i>	50 x 45 x 50  0,117 m <sup>3</sup> 1 u	<b>64</b>	<b>71</b>	<b>76</b>	<b>81</b>
 <b>3100</b>	Buck de 100 con 2 cajones (con ruedas) <i>Buck with 2 drawers (with wheels)</i>	100 x 45 x 50  0,233 m <sup>3</sup> 1 u	<b>107</b>	<b>119</b>	<b>127</b>	<b>136</b>







**Módulos sobreBuk**  
**Buck modules**

Ref.	Descripción Description	Medidas cm Measure cm	Puntos Points			
			A	B	C	A la Arena
 <b>3101</b>	Estantería sobre buck (completa altura 240) <i>Shelving above the buck</i>	50 x 195 x 42  0,425 m <sup>3</sup> 1 u	<b>98</b>	<b>109</b>	<b>116</b>	<b>124</b>
 <b>3102</b>	Estantería sobre buck (completa altura 200) <i>Shelving above the buck</i>	50 x 155 x 42  0,338 m <sup>3</sup> 1 u	<b>80</b>	<b>89</b>	<b>95</b>	<b>102</b>









**MÓDULOS DE 108 DE ALTURA - fondo 42 (medida de tapa incluida)**  
**MODULES HEIGHT 108 - depth 42, (including top measure)**

Ref.	Descripción Description	Medidas cm Measure cm	Puntos Points			
			A	B	C	A la Arena
	3103 Módulo bajo diáfano de 40 (sin tapa) <i>Low module (without top)</i>	40 x 108 x 40	55	61	65	70
		 0,180  1 u				
	3104 Módulo cajones con hueco de 40 (sin tapa) <i>Drawers module with hollow (without top)</i>	40 x 108 x 42	100	111	119	127
		 0,185  1 u				
	3105 Módulo puerta derecha y hueco de 40 (sin tapa) <i>Module with right door &amp; hollow (without top)</i>	40 x 108 x 42	70	78	83	89
	3106 Módulo puerta izquierda y hueco de 40 (sin tapa) <i>Module with left door &amp; hollow (without top)</i>	40 x 108 x 42	70	78	83	89
		 0,185  1 u				
	3107 Módulo cajones de 40 (sin tapa) <i>Drawers module (without top)</i>	40 x 108 x 42	125	139	148	158
		 0,185  1 u				
	3108 Módulo cajones con hueco de 50 (sin tapa) <i>Drawers module with hollow (without top)</i>	50 x 108 x 42	115	128	137	147
		 0,236  1 u				
	3109 Módulo cajones de 50 (sin tapa) <i>Drawers module (without top)</i>	50 x 108 x 42	141	156	167	179
		 0,236  1 u				

**MÓDULOS DE 108 DE ALTURA - fondo 42 (medida de tapa incluida)**  
**MODULES HEIGHT 108 - depth 42, (including top measure)**

Ref.	Descripción Description	Medidas cm Measure cm	Puntos Points			
			A	B	C	A la Arena
	3110 Módulo cajones con hueco de 80 (sin tapa) <i>Drawers module with hollow (without top)</i>	80 x 108 x 42	154	171	183	196
		 0,376  1 u				
	3111 Módulo cajones de 80 (sin tapa) <i>Drawers module (without top)</i>	80 x 108 x 42	190	211	226	242
		 0,376  1 u				



















**Tapas para módulos de 108 de altura (precio incluido en módulo)**  
**Top for modules height 108 (price included in module)**

Ref.	Descripción Description	Medidas cm Measure cm	Puntos Points			
			A	B	C	A la Arena
	3112 Tapa de ancho 40 <i>Top 40 cm</i>	40 x 2'3 X 45				
		 0,006  1 u				
	3113 Tapa de ancho 50 <i>Top 50 cm</i>	50 x 2'3 X 45				
		 0,007  1 u				
	3114 Tapa de ancho 80 <i>Top 80 cm</i>	80 x 2'3 X 45				
		 0,011  1 u				









**Tapas para módulos de 108 de altura (precio incluido en modulo)**

Top for modules height 108 (price included in module)

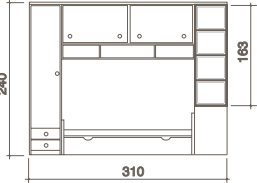
Ref.	Descripción Description	Medidas cm Measure cm	Puntos Points			
			A	B	C	A la Arena
 <b>3115</b>	Tapa de ancho 90 Top 90 cm	90 x 2'3 X 45  0,012   1 u				
 <b>3116</b>	Tapa de ancho 100 Top 100 cm	100 x 2'3 X 45  0,014   1 u				
 <b>3117</b>	Tapa de ancho 120 Top 120 cm	120 x 2'3 X 45  0,017   1 u				
 <b>3118</b>	Tapa de ancho 130 Top 130 cm	130 x 2'3 X 45  0,018   1 u				
 <b>3119</b>	Tapa de ancho 150 Top 150 cm	150 x 2'3 X 45  0,021   1 u				
 <b>3120</b>	Tapa de ancho 160 Top 160 cm	160 x 2'3 X 45  0,022   1 u				



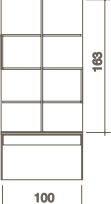



**Estanterías sobre arcón para 240**

Shelving above the module for 240

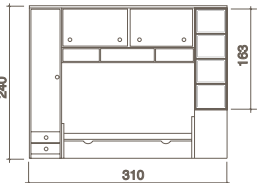

Ref.	Descripción Description	Medidas cm Measure cm	Puntos Points			
			A	B	C	A la Arena
 <b>3079</b>	Módulo alto de 163 diáfano Open upper module 163 	50 x 163 x 40  0,339   1 u	83	92	99	106
 <b>3080</b>	Módulo estante de 163 diáfano Shelf module 163 	100 x 163 x 25  0,427   1 u	85	94	101	108

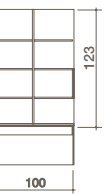





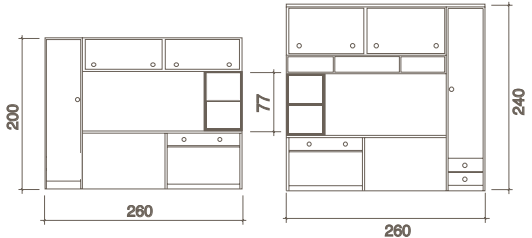





**Estanterías sobre arcón para 200**



















Shelving above the module for 200

Ref.	Descripción Description	Medidas cm Measure cm	Puntos Points			
			A	B	C	A la Arena
 <b>3081</b>	Módulo alto de 123 diáfano Open upper module 123 	50 x 123 x 25  0,162   1 u	48	53	57	61
 <b>3082</b>	Módulo estante de 123 diáfano Shelf module 123 	100 x 123 x 25  0,323   1 u	64	71	76	81

















**Estanterías sobre arcón para 200**  
Shelving above the module for 200

Ref.	Descripción Description	Medidas cm Measure cm	Puntos Points			
			A	B	C	A la Arena
3083	 Módulo alto de 77 diáfano de fondo 25 <i>High module height 77, depth 25</i>	 50 x 77 x 25	31	34	37	40
			 0,102  1 u			

Altillos High modules	Ref.	Descripción Description	Medidas cm Measure cm	Puntos Points			
				A	B	C	A la Arena
	7044	Altillo 2 puertas correderas <i>High module with sliding doors</i>	210 x 86 x 42	247	272	294	315
				 0,175  4 u			
	3122	Altillo de 2 puertas elevables de 210 <i>High module with 2 lift up doors</i>	210 x 61 x 42	193	214	229	245
				 0,557  1 u			
	3127	Altillo de 2 puertas elevables de 210 (fondo 25) <i>High module with 2 lift up doors</i>	210 x 46 x 27	127	141	151	162
				 0,274  1 u			
	3124	Altillo de 1 puerta elevable de 100 <i>High module with 1 lift up doors</i>	100 x 61 x 42	98	109	116	124
				 0,266  1 u			

Altillos High modules	Ref.	Descripción Description	Medidas cm Measure cm	Puntos Points			
				A	B	C	A la Arena
	3128	Altillo de 1 puerta elevable 100 (fondo 25) <i>High module with 1 lift up door</i>	100 x 46 x 27	70	78	83	89
				 0,131  1 u			
	3123	Altillo de 2 puertas 100 <i>High module with 2 doors</i>	100 x 86 x 42	124	138	147	157
				 0,374  1 u			
	3125	Altillo de 1 puerta de 50 derecha <i>High module with 1 right door</i>	50 x 86 x 42	77	85	91	97
	3126	Altillo de 1 puerta de 50 izquierda <i>High module with 1 left door</i>	50 x 86 x 42	77	85	91	97
				 0,188  1 u			
	3129	Alto estante de 210 (para 200 y 240 fondo 25) <i>High wall shelf</i>	210 x 25 x 25	55	61	65	70
				 0,140  1 u			
	3041	Costado puente de 240 <i>Central bridge panel 240</i>	40 x 240 x 3	40	44	47	50
				 0,029  1 u			
	3042	Costado puente de 200 <i>Central bridge panel 200</i>	40 x 200 x 3	33	37	39	42
				 0,024  1 u			

**MÓDULOS DE 40 - fondo 40 - alto 200**  
**MODULES of 40, depth 40, height 200**

Ref.	Descripción Description	Medidas cm Measure cm	Puntos Points			
			A	B	C	A la Arena
 <b>3130</b>	Estantería diáfana de 40 de 200 <i>Shelving</i>	40 x 200 x 42  0,349   1 u	<b>90</b>	<b>100</b>	<b>107</b>	<b>114</b>
 <b>3131</b>	Estantería diáfana adaptable de 15 a 39 cm de 200 <i>Adaptable shelving</i>	___ x 200 x 42  1 u 	<b>108</b>	<b>120</b>	<b>128</b>	<b>137</b>
 <b>3132</b>	Estantería de puerta derecha y hueco de 40 de 200 <i>Shelving with right door &amp; hollow</i>	40 x 200 x 42	<b>105</b>	<b>116</b>	<b>125</b>	<b>134</b>
 <b>3133</b>	Estantería de puerta izquierda y hueco de 40 de 200 <i>Shelving with left door &amp; hollow</i>	0,349   1 u	<b>105</b>	<b>116</b>	<b>125</b>	<b>134</b>
 <b>3134</b>	Estantería de 2 puertas y derechas y hueco de 40 x 200 <i>Shelving with right 2 doors &amp; hollow</i>	40 x 200 x 42	<b>117</b>	<b>130</b>	<b>139</b>	<b>149</b>
 <b>3135</b>	Estantería de 2 puertas izquierdas y hueco de 40 de 200 <i>Shelving with left 2 doors &amp; hollow</i>	0,349   1 u	<b>117</b>	<b>130</b>	<b>139</b>	<b>149</b>
 <b>3136</b>	Estantería de cajones y hueco de 40 de 200 <i>Shelving with drawers &amp; hollow</i>	40 x 200 x 42  0,349   1 u	<b>135</b>	<b>150</b>	<b>160</b>	<b>171</b>













**MÓDULOS DE 40 - fondo 40 - alto 200**  
**MODULES of 40, depth 40, height 200**

Ref.	Descripción Description	Medidas cm Measure cm	Puntos Points			
			A	B	C	A la Arena
 <b>3137</b>	Estantería de cajones y puerta de 40 de 200 derecha <i>Shelving with right door &amp; drawers</i>	40 x 200 x 42	<b>146</b>	<b>162</b>	<b>173</b>	<b>185</b>
 <b>3138</b>	Estantería de cajones y puerta de 40 de 200 izquierda <i>Shelving with left door &amp; drawers</i>	0,419   1 u	<b>146</b>	<b>162</b>	<b>173</b>	<b>185</b>

















**MÓDULOS DE 40 - fondo 40 - alto 240**  
**MODULES of 40, depth 40, height 240**

Ref.	Descripción Description	Medidas cm Measure cm	Puntos Points			
			A	B	C	A la Arena
 <b>3139</b>	Estantería diáfana de 40 de 240 <i>Shelving</i>	40 x 240 x 42  0,419   1 u	<b>107</b>	<b>119</b>	<b>127</b>	<b>136</b>
 <b>3140</b>	Estantería diáfana adaptable de 15 a 39 cm de 240 <i>Adaptable shelving</i>	___ x 240 x 42  0,419   1 u	<b>124</b>	<b>138</b>	<b>147</b>	<b>157</b>

**MÓDULOS DE 40 - fondo 40 - alto 240**  
**MODULES of 40, depth 40, height 240**

Ref.	Descripción Description	Medidas cm Measure cm	Puntos Points			
			A	B	C	A la Arena
	3141 Estantería de puerta y hueco de 40 de 240 derecha <i>Shelving with right door &amp; hollow</i>	40 x 240 x 42	122	135	145	155
		 0,419  1 u				
	3142 Estantería de puerta y hueco de 40 de 240 izquierda <i>Shelving with left door &amp; hollow</i>	40 x 240 x 42	122	135	145	155
		 0,419  1 u				
	3143 Estantería de 2 puertas y hueco de 40 de 240 derecha <i>Shelving with right 2 doors &amp; hollow</i>	40 x 240 x 42	140	155	166	178
		 0,419  1 u				
	3144 Estantería de 2 puertas y hueco de 40 de 240 izquierda <i>Shelving with left 2 doors &amp; hollow</i>	40 x 240 x 42	140	155	166	178
		 0,419  1 u				
	3145 Estantería de cajones y hueco de 40 de 240 <i>Shelving with drawers &amp; hollow</i>	40 x 240 x 42	152	169	181	194
		0,419  1 u				
	3146 Estantería de cajones y puerta de 40 de 240 derecha <i>Shelving with right door &amp; drawers</i>	40 x 240 x 42	170	189	202	216
		0,419  1 u				
	3147 Estantería de cajones y puerta de 40 de 240 izquierda <i>Shelving with left door &amp; drawers</i>	40 x 240 x 42	170	189	202	216
		0,419  1 u				

**Armarios de 200 Camelia**  
**Closet of 200 (Camelia)**

Ref.	Descripción Description	Medidas cm Measure cm	Puntos Points			
			A	B	C	A la Arena
	7045 Armario 2 puertas 100 cristal Camelia de 200 <i>Closet Camelia with 2 glass doors</i>	100 x 200 x 57	219	243	260	278
		 0,464  4 u				
	7046 Armario 2 puertas 100 madera Camelia de 200 <i>Closet Camelia with 2 wood doors</i>	100 x 200 x 57	219	243	260	278
		 0,464  4 u				
	7047 Armario 1 puerta 50 cristal derecha Camelia de 200 <i>Closet Camelia with 1 right glass door</i>	50 x 200 x 57	143	159	170	182
		 0,160  2 u				
	7048 Armario 1 puerta 50 cristal izquierda Camelia de 200 <i>Closet Camelia with 1 left glass door</i>	50 x 200 x 57	143	159	170	182
		 0,160  2 u				
	7049 Armario 1 puerta 50 madera derecha Camelia de 200 <i>Closet Camelia with 1 right wood door</i>	50 x 200 x 57	143	159	170	182
		 0,160  2 u				
	7050 Armario 1 puerta 50 madera izquierda Camelia de 200 <i>Closet Camelia with 1 left wood door</i>	50 x 200 x 57	143	159	170	182
		0,160  2 u				
	7051 Armario diáfano con cajones y estantes de 200 <i>Closet Camelia with drawers &amp; shelves</i>	50 x 200 x 57	216	240	257	275
		0,284  4 u				

















**Armarios de 200 Camelia**  
Closet of 200 (Camelia)

Ref.	Descripción Description	Medidas cm Measure cm	Puntos Points			
			A	B	C	A la Arena
7052	Terminal vestidor de 200 derecho con espejo <i>Terminal closet with mirror right</i>	20 x 200 x 57	76	84	90	96
			0,243	1 u		
7053	Terminal vestidor de 200 izquierdo con espejo <i>Terminal closet with mirror left</i>		76	84	90	96
7054	Armario rincón en chaflán cristal derecha Camelia de 200 <i>Chamfered corner glass closet right Camelia</i>	95 x 200 x 95	282	313	335	358
			0,282	4 u		
7055	Armario rincón en chaflán cristal izquierda Camelia de 200 <i>Chamfered corner glass closet left Camelia</i>		282	313	335	358
7056	Armario rincón en chaflán madera derecha Camelia de 200 <i>Chamfered corner wood closet right Camelia</i>	95 x 200 x 95	282	313	335	358
			0,282	4 u		
7057	Armario rincón en chaflán madera izquierda Camelia de 200 <i>Chamfered corner wood closet left Camelia</i>		282	313	335	358





















**Armarios de 200 (Camelia)**  
Closet of 200 (Camelia)

Ref.	Descripción Description	Medidas cm Measure cm	Puntos Points			
			A	B	C	A la Arena
7058	Armario rincón en "L" cristal Camelia de 200 (derecho) <i>Corner closet shaped "L" with glass Camelia (right)</i>	120 x 200 x 106	344	382	409	438
			0,520	4 u		
7059	Armario rincón en "L" cristal Camelia de 200 (izquierdo) <i>Corner closet shaped "L" with glass Camelia (left)</i>	120 x 200 x 106	344	382	409	438
			0,520	4 u		
7060	Armario rincón en "L" madera Camelia de 200 (derecho) <i>Corner wood closet shaped "L" Camelia (right)</i>	120 x 200 x 106	344	382	409	438
			0,520	4 u		
7061	Armario rincón en "L" madera Camelia de 200 (izquierdo) <i>Corner wood closet shaped "L" Camelia (left)</i>	120 x 200 x 106	344	382	409	438
			0,520	4 u		
7062	Cajonera interior para armario de rincón en chaflán sin tapa <i>Interior buck for chamfered corner closet</i>	40 x 48 x 5	46	51	55	59
			0,088	1 u		
7063	Cajonera interior para armario de rincón en "L" sin tapa <i>Interior buck shaped "L" for corner closet</i>	50 x 48 x 45	50	55	59	63
			0,110	1 u		
7064	Cajonera opcional para armario de 50 sin tapa <i>Optional buck for closet 50</i>	46 x 35 x 51	40	44	47	50
			0,084	1 u		
7065	Cajonera opcional para armario de 100 sin tapa <i>Optional buck for closet 100</i>	96 x 35 x 51	64	71	76	81
			0,175	1 u		

**Armarios de 240 (Camelia)**  
Closet of 240 (Camelia)

Ref.	Descripción Description	Medidas cm Measure cm	Puntos Points			
			A	B	C	A la Arena
	7066 Armario 2 puertas 100 cristal 2 cajones Camelia de 240 Closet Camelia with 2 glass doors & 2 drawers	100 x 240 x 57	313	347	372	398
		 0,389  5 u				
	7067 Armario 2 puertas 100 cristal 1 cajón Camelia de 240 Closet Camelia with 2 glass doors & 1 drawers	100 x 240 x 57	299	332	355	380
		 0,389  5 u				
	7068 Armario 2 puertas 100 madera 2 cajones Camelia de 240 Closet Camelia with 2 wood doors & 2 drawers	100 x 240 x 57	313	343	372	398
		 0,389  5 u				
	7069 Armario 2 puertas 100 madera 1 cajón Camelia de 240 Closet Camelia with 2 wood doors & 1 drawer	100 x 240 x 57	299	332	355	380
		 0,389  5 u				
	7070 Armario 1 puerta 50 cristal 2 cajones derecha Camelia de 240 Closet Camelia with right 1 glass door & 2 drawers	50 x 240 x 57	208	231	247	264
		 0,261  3 u				
	7071 Armario 1 puerta 50 cristal 2 cajones izquierda Camelia de 240 Closet Camelia with left 1 glass door & 2 drawers		208	231	247	264

**Armarios de 240 Camelia**  
Closet of 240 (Camelia)

Ref.	Descripción Description	Medidas cm Measure cm	Puntos Points			
			A	B	C	A la Arena
	7072 Armario 1 puerta 50 cristal 1 cajón derecha Camelia de 240 Closet Camelia with right 1 glass door & 1 drawers	50 x 240 x 57	199	221	236	253
		 0,261  3 u				
	7073 Armario 1 puerta 50 cristal 1 cajón izquierda Camelia de 240 Closet Camelia with left 1 glass door & 1 drawers		199	221	236	253
		 0,261  3 u				
	7074 Armario 1 puerta 50 madera 2 cajones derecha Camelia de 240 Closet Camelia with right 1 wood door & 2 drawers	50 x 240 x 57	208	231	247	264
		 0,261  3 u				
	7075 Armario 1 puerta 50 madera 2 cajones izquierda Camelia de 240 Closet Camelia with left 1 wood door & 2 drawers		208	231	247	264
		 0,261  3 u				
	7076 Armario 1 puerta 50 madera 1 cajón derecha Camelia de 240 Closet Camelia with right 1 wood door & 1 drawers	50 x 240 x 57	199	221	236	253
		 0,261  3 u				
	7077 Armario 1 puerta 50 madera 1 cajón izquierda Camelia de 240 Closet Camelia with left 1 wood door & 1 drawers		199	221	236	253
		 0,261  3 u				
	7078 Armario diáfano con cajones y estantes de 240 Closet with drawers & shelves	50 x 240 x 57	218	242	259	277
		 0,301  3 u				



**Armarios de 240 Camelia**  
Closet of 240 (Camelia)

Ref.	Descripción Description	Medidas cm Measure cm	Puntos Points			
			A	B	C	A la Arena
7079	Terminal vestidor de 240 derecho con espejo <i>Terminal closet with mirror right</i>	20 x 240 x 57	91	101	108	116
		0,291  1 u				
7080	Terminal vestidor de 240 izquierdo con espejo <i>Terminal closet with mirror left</i>	20 x 240 x 57	91	101	108	116
		0,291  1 u				
7081	Armario rincón en chaflán cristal derecha Camelia de 240 <i>Chamfered corner glass closet right Camelia</i>	120 x 240 x 106	337	374	400	428
		0,499  4 u				
7082	Armario rincón en chaflán cristal izquierda Camelia de 240 <i>Chamfered corner glass closet left Camelia</i>	95 x 240 x 95	337	374	400	428
		0,425  4 u				
7083	Armario rincón en chaflán madera derecha Camelia de 240 <i>Chamfered corner wood closet right Camelia</i>	120 x 240 x 106	337	374	400	428
		0,499  4 u				
7084	Armario rincón en chaflán madera izquierdo Camelia de 240 <i>Chamfered corner wood closet left Camelia</i>	95 x 240 x 95	337	374	400	428
		0,425  4 u				
7085	Armario rincón en "L" cristal Camelia de 240 (derecho) <i>Corner closet shaped "L" with glass Camelia (right)</i>	120 x 240 x 106	419	465	498	533
		0,499  4 u				
7086	Armario rincón en "L" cristal Camelia de 240 (izquierdo) <i>Corner closet shaped "L" with glass Camelia (left)</i>	120 x 240 x 106	419	465	498	533
		0,499  4 u				





**Armarios de 240 Camelia**  
Closet of 240 (Camelia)

Ref.	Descripción Description	Medidas cm Measure cm	Puntos Points			
			A	B	C	A la Arena
7087	Armario rincón en "L" madera Camelia de 240 (derecho) <i>Corner wood closet shaped "L" Camelia (right)</i>	120 x 240 x 106	419	465	498	533
		0,499  4 u				
7088	Armario rincón en "L" madera Camelia de 240 (izquierdo) <i>Corner wood closet shaped "L" Camelia (left)</i>	120 x 240 x 106	419	465	498	533
		0,499  4 u				
7089	Armario Camelia puertas correderas de 160 <i>Closet Camelia with sliding doors</i>	160 x 240 x 57	447	491	530	568
		0,722  6 u				
7062	Cajonera interior para armario de rincón en chaflán sin tapa <i>Interior buck for chamfered corner closet</i>	40 x 48 x 45	46	51	55	59
		0,088  1 u				
7063	Cajonera interior para armario de rincón en "L" sin tapa <i>Interior buck shaped "L" for corner closet</i>	50 x 48 x 45	50	55	59	63
		0,110  1 u				
7064	Cajonera opcional para armario de 50 sin tapa <i>Optional buck for closet 50</i>	46 x 35 x 51	40	44	47	50
		0,084  1 u				
7065	Cajonera opcional para armario de 100 sin tapa <i>Optional buck for closet 100</i>	96 x 35 x 51	64	71	76	81
		0,175  1 u				





**Armarios de 240 Camelia**  
Closet of 240 (Camelia)

Ref.	Descripción Description	Medidas cm Measure cm	Puntos Points			
			A	B	C	A la Arena
 <b>7090</b>	Estante interior para armario de 1 puerta <i>Interior shelf for closet with 1 door</i>	46 x 2 x 51  0,005 m <sup>2</sup> 1 u	9	10	11	12
 <b>7091</b>	Estante interior para armario de 2 puertas <i>Interior shelf for closet with 2 door</i>	96 x 2 x 51  0,010 m <sup>2</sup> 1 u	17	19	20	21

**Armarios de 200 Delia**  
Closet of 200 (Delia)

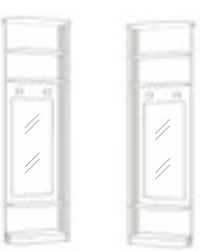
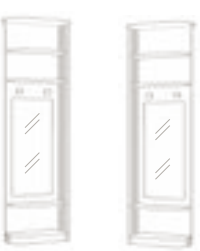

Ref.	Descripción Description	Medidas cm Measure cm	Puntos Points			
			A	B	C	A la Arena
 <b>7092</b>	Armario 2 puertas 100 cristal Delia de 200 <i>Closet Delia with 2 glass doors</i>	100 x 200 x 57  0,464 m <sup>2</sup> 3 u	219	243	260	278
 <b>7093</b>	Armario 2 puertas 100 madera Delia de 200 <i>Closet Delia with 2 wood doors</i>	100 x 200 x 57  0,464 m <sup>2</sup> 3 u	219	243	260	278
 <b>7094</b>	Armario 1 puerta 50 cristal derecha Delia de 200 <i>Closet Delia with 1 right glass door</i>	50 x 200 x 57  0,160 m <sup>2</sup> 2 u	143	159	170	182
 <b>7095</b>	Armario 1 puerta 50 cristal izquierda Delia de 200 <i>Closet Delia with 1 left glass door</i>	50 x 200 x 57  0,160 m <sup>2</sup> 2 u	143	159	170	182

**Armarios de 200 Delia**  
Closet of 200 (Delia)



Ref.	Descripción Description	Medidas cm Measure cm	Puntos Points			
			A	B	C	A la Arena
 <b>7096</b>	Armario 1 puerta 50 madera derecha Delia de 200 <i>Closet Delia with 1 right wood door</i>	50 x 200 x 57  0,160 m <sup>2</sup> 2 u	143	159	170	182
 <b>7097</b>	Armario 1 puerta 50 madera izquierda Delia de 200 <i>Closet Delia with 1 left wood door</i>	50 x 200 x 57  0,160 m <sup>2</sup> 2 u	143	159	170	182
 <b>7098</b>	Armario diáfano con cajones y estantes de 200 <i>Closet with drawers &amp; shelves</i>	50 x 200 x 57  0,284 m <sup>2</sup> 4 u	216	240	257	275
 <b>7052</b>	Terminal vestidor de 200 derecho con espejo <i>Terminal closet with mirror right</i>	20 x 200 x 57  0,243 m <sup>2</sup> 1 u	76	84	90	96
 <b>7053</b>	Terminal vestidor de 200 izquierdo con espejo <i>Terminal closet with mirror left</i>	20 x 200 x 57  0,243 m <sup>2</sup> 1 u	76	84	90	96
 <b>7101</b>	Armario rincón chaflán cristal derecha Delia de 200 <i>Chamfered corner glass closet right Delia</i>	95 x 200 x 95  0,393 m <sup>2</sup> 4 u	282	313	335	358
 <b>7102</b>	Armario rincón chaflán cristal izquierda Delia de 200 <i>Chamfered corner glass closet left Delia</i>	95 x 200 x 95  0,393 m <sup>2</sup> 4 u	282	313	335	358

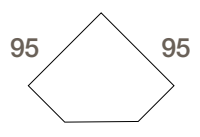
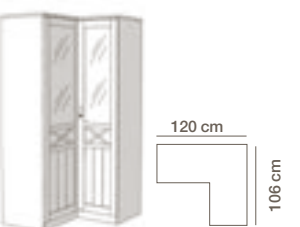
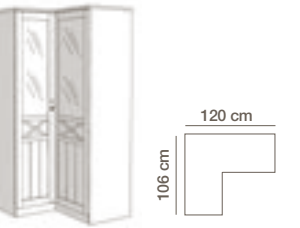
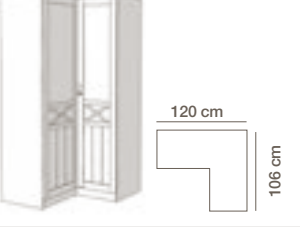
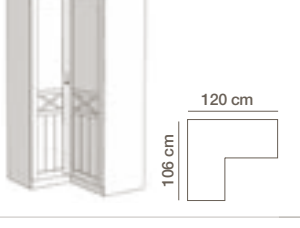





**Armarios de 200 (Delia)**  
Closet of 200 (Delia)

Ref.	Descripción Description	Medidas cm Measure cm	Puntos Points			
			A	B	C	A la Arena
	<b>7103</b> Armario rincón chaflán madera derecha Delia de 200 <i>Chamfered corner wood closet right Delia</i>	95 x 200 x 95	<b>282</b>	<b>313</b>	<b>335</b>	<b>358</b>
	<b>7104</b> Armario rincón chaflán madera izquierda Delia de 200 <i>Chamfered corner wood closet left Delia</i>	0,393 m <sup>2</sup> 4 u	<b>282</b>	<b>313</b>	<b>335</b>	<b>358</b>
	<b>7099</b> Armario rincón en "L" cristal Delia de 200 (derecho) <i>Corner closet shaped "L" with glass Delia (right)</i>	120 x 200 x 106 0,520 m <sup>2</sup> 4 u	<b>344</b>	<b>382</b>	<b>409</b>	<b>438</b>
	<b>7100</b> Armario rincón en "L" cristal Delia de 200 (izquierdo) <i>Corner closet shaped "L" with glass Delia (left)</i>	120 x 200 x 106 0,520 m <sup>2</sup> 4 u	<b>344</b>	<b>382</b>	<b>409</b>	<b>438</b>
	<b>7105</b> Armario rincón en "L" madera Delia de 200 (derecho) <i>Corner wood closet shaped "L" Delia (right)</i>	120 x 200 x 106 0,520 m <sup>2</sup> 4 u	<b>344</b>	<b>382</b>	<b>409</b>	<b>438</b>
	<b>7106</b> Armario rincón en "L" madera Delia de 200 (izquierdo) <i>Corner wood closet shaped "L" Delia (left)</i>	120 x 200 x 106 0,520 m <sup>2</sup> 4 u	<b>344</b>	<b>382</b>	<b>409</b>	<b>438</b>
	<b>7062</b> Cajonera interior para armario de rincón en chaflán sin tapa <i>Interior buck for chamfered corner closet</i>	40 x 48 x 45 0,088 m <sup>2</sup> 4 u	<b>46</b>	<b>51</b>	<b>55</b>	<b>59</b>













**Armarios de 200 Delia**  
Closet of 200 (Delia)

Ref.	Descripción Description	Medidas cm Measure cm	Puntos Points			
			A	B	C	A la Arena
	<b>7063</b> Cajonera interior para armario de rincón en "L" sin tapa <i>Interior buck shaped "L" for corner closet</i>	50 x 48 x 45 0,110 m <sup>2</sup> 1 u	<b>50</b>	<b>55</b>	<b>59</b>	<b>63</b>
	<b>7064</b> Cajonera opcional para armario de 50 sin tapa <i>Optional buck for closet 50</i>	46 x 35 x 51 0,084 m <sup>2</sup> 1 u	<b>40</b>	<b>44</b>	<b>47</b>	<b>50</b>
	<b>7065</b> Cajonera opcional para armario de 100 sin tapa <i>Optional buck for closet 100</i>	96 x 35 x 51 0,175 m <sup>2</sup> 1 u	<b>64</b>	<b>71</b>	<b>76</b>	<b>81</b>





















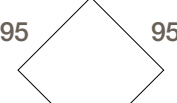

**Armarios de 240 (Delia)**  
Closet of 240 (Delia)

Ref.	Descripción Description	Medidas cm Measure cm	Puntos Points			
			A	B	C	A la Arena
	<b>7107</b> Armario 2 puertas 100 cristal 2 cajones Delia de 240 <i>Closet Delia with 2 glass doors &amp; 2 drawers</i>	100 x 240 x 57 0,389 m <sup>2</sup> 5 u	<b>313</b>	<b>347</b>	<b>372</b>	<b>398</b>
	<b>7108</b> Armario 2 puertas 100 cristal 1 cajón Delia de 240 <i>Closet Delia with 2 glass doors &amp; 1 drawer</i>	100 x 240 x 57 0,389 m <sup>2</sup> 5 u	<b>299</b>	<b>332</b>	<b>355</b>	<b>380</b>
	<b>7109</b> Armario 2 puertas 100 madera 2 cajones Delia de 240 <i>Closet Delia with 2 wood doors &amp; 2 drawers</i>	100 x 240 x 57 0,389 m <sup>2</sup> 5 u	<b>313</b>	<b>347</b>	<b>372</b>	<b>398</b>
	<b>7110</b> Armario 2 puertas 100 madera 1 cajón Delia de 240 <i>Closet Delia with 2 wood doors &amp; 1 drawer</i>	100 x 240 x 57 0,389 m <sup>2</sup> 5 u	<b>299</b>	<b>332</b>	<b>355</b>	<b>380</b>



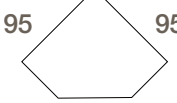

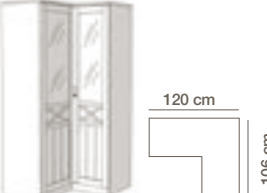

**Armarios de 240 Delia**  
Closet of 240 (Delia)

Ref.	Descripción Description	Medidas cm Measure cm	Puntos Points			
			A	B	C	A la Arena
	<b>7111</b> Armario 1 puerta 50 cristal 2 cajones derecha Delia de 240 <i>Closet Delia with 1 right glass doors &amp; 2 drawers</i>	50 x 240 x 57	<b>208</b>	<b>231</b>	<b>247</b>	<b>264</b>
	<b>7112</b> Armario 1 puerta 50 cristal 2 cajones izquierda Delia de 240 <i>Closet Delia with 1 left glass door &amp; 2 drawers</i>	 0,261  3 u	<b>208</b>	<b>231</b>	<b>247</b>	<b>264</b>
	<b>7113</b> Armario 1 puerta 50 cristal 1 cajón derecha Delia de 240 <i>Closet Delia with 1 right glass door &amp; 1 drawer</i>	50 x 240 x 57	<b>199</b>	<b>221</b>	<b>236</b>	<b>253</b>
	<b>7114</b> Armario 1 puerta 50 cristal 1 cajón izquierda Delia de 240 <i>Closet Delia with 1 left glass door &amp; 1 drawer</i>	 0,261  3 u	<b>199</b>	<b>221</b>	<b>236</b>	<b>253</b>
	<b>7115</b> Armario 1 puerta 50 madera 2 cajones derecha Delia de 240 <i>Closet Delia with 1 right wood door &amp; 2 drawers</i>	50 x 240 x 57	<b>208</b>	<b>231</b>	<b>247</b>	<b>264</b>
	<b>7116</b> Armario 1 puerta 50 madera 2 cajones izquierda Delia de 240 <i>Closet Delia with 1 left wood door &amp; 2 drawers</i>	 0,261  3 u	<b>208</b>	<b>231</b>	<b>247</b>	<b>264</b>
	<b>7117</b> Armario 1 puerta 50 madera 1 cajón derecha Delia de 240 <i>Closet Delia with 1 right wood door &amp; 1 drawer</i>	50 x 240 x 57	<b>199</b>	<b>221</b>	<b>236</b>	<b>253</b>
	<b>7118</b> Armario 1 puerta 50 madera 1 cajón izquierda Delia de 240 <i>Closet Delia with 1 left wood door &amp; 1 drawer</i>	 0,261  3 u	<b>199</b>	<b>221</b>	<b>236</b>	<b>253</b>

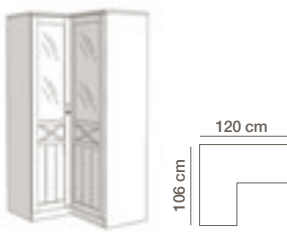
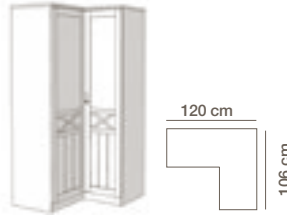
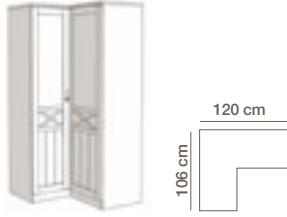

**Armarios de 240 Delia**  
Closet of 240 (Delia)

Ref.	Descripción Description	Medidas cm Measure cm	Puntos Points			
			A	B	C	A la Arena
	<b>7078</b> Armario diáfano con cajones y estantes de 240 <i>Closet with drawers &amp; shelves</i>	50 x 240 x 57	<b>218</b>	<b>242</b>	<b>259</b>	<b>277</b>
		 0,301  3 u				
	<b>7079</b> Terminal vestidor de 240 derecho con espejo <i>Terminal closet with mirror right</i>	20 x 240 x 57	<b>91</b>	<b>101</b>	<b>108</b>	<b>116</b>
		 0,291  1 u				
	<b>7080</b> Terminal vestidor de 240 izquierdo con espejo <i>Terminal closet with mirror left</i>	20 x 240 x 57	<b>91</b>	<b>101</b>	<b>108</b>	<b>116</b>
		 0,291  1 u				
	<b>7122</b> Armario rincón en chaflán cristal derecha Delia de 240 <i>Chamfered corner glass closet right Delia</i>	95 x 240 x 95	<b>337</b>	<b>374</b>	<b>400</b>	<b>428</b>
		 0,425  4 u				
	<b>7123</b> Armario rincón en chaflán cristal izquierda Delia de 240 <i>Chamfered corner glass closet left Camelia</i>	95 x 240 x 95	<b>337</b>	<b>374</b>	<b>400</b>	<b>428</b>
		 0,425  4 u				
	<b>7124</b> Armario rincón en chaflán madera derecha Delia de 240 <i>Chamfered corner wood closet right Delia</i>	95 x 240 x 95	<b>337</b>	<b>374</b>	<b>400</b>	<b>428</b>
		 0,425  4 u				
	<b>7125</b> Armario rincón en chaflán madera izquierda Delia de 240 <i>Chamfered corner wood closet left Delia</i>	95 x 240 x 95	<b>337</b>	<b>374</b>	<b>400</b>	<b>428</b>
		 0,425  4 u				
	<b>7126</b> Armario rincón en "L" cristal Delia de 240 (derecho) <i>Corner closet shaped "L" with glass Delia (right)</i>	120 x 240 x 106	<b>419</b>	<b>465</b>	<b>498</b>	<b>533</b>
		 0,499  4 u				

**Armarios de 240**  
**Delia**  
Closet of 240 (Delia)

Ref.	Descripción Description	Medidas cm Measure cm	Puntos Points			
			A	B	C	A la Arena
 <b>7127</b>	Armario rincón en "L" cristal Delia de 240 (izquierdo) <i>Corner closet shaped "L" with glass Delia (left)</i>	120 x 240 x 106  0,499 m <sup>3</sup> 4 u	419	465	498	533
 <b>7128</b>	Armario rincón en "L" madera Delia de 240 (derecho) <i>Corner wood closet shaped "L" Delia (right)</i>	120 x 240 x 106  0,499 m <sup>3</sup> 4 u	419	465	498	533
 <b>7129</b>	Armario rincón en "L" madera Delia de 240 (izquierda) <i>Corner wood closet shaped "L" Delia (left)</i>	120 x 240 x 106  0,499 m <sup>3</sup> 4 u	419	465	498	533
 <b>7130</b>	Armario Delia puertas correderas de 160 <i>Closet Delia with sliding doors</i>	160 x 240 x 57  0,722 m <sup>3</sup> 6 u	449	494	534	571
 <b>7062</b>	Cajonera interior para armario de rincón en chaflán sin tapa <i>Interior buck for chamfered corner closet</i>	40 x 48 x 45  0,088 m <sup>3</sup> 1 u	46	51	55	59
 <b>7063</b>	Cajonera interior para armario de rincón en "L" sin tapa <i>Interior buck shaped "L" for corner closet</i>	50 x 48 x 45  0,110 m <sup>3</sup> 1 u	50	55	59	63
 <b>7064</b>	Cajonera opcional para armario de 50 sin tapa <i>Optional buck for closet 50</i>	46 x 35 x 51  0,084 m <sup>3</sup> 1 u	40	44	47	50
 <b>7065</b>	Cajonera opcional para armario de 100 sin tapa <i>Optional buck for closet 100</i>	96 x 35 x 51  0,175 m <sup>3</sup> 1 u	64	71	76	81

**Armarios de 240**  
**Delia**  
Closet of 240 (Delia)

Ref.	Descripción Description	Medidas cm Measure cm	Puntos Points			
			A	B	C	A la Arena
 <b>7090</b>	Estante interior para armario de 1 puerta <i>Interior shelf for closet with 1 door</i>	46 x 2 x 51  0,005 m <sup>3</sup> 1 u	9	10	11	12
 <b>7091</b>	Estante interior para armario de 2 puertas <i>Interior shelf for closet with 2 doors</i>	96 x 2 x 51  0,010 m <sup>3</sup> 1 u	17	19	20	21

**Distribución interior armarios rincón y chaflán**  
*Inner distribution for inside and outside corner wardrobes*

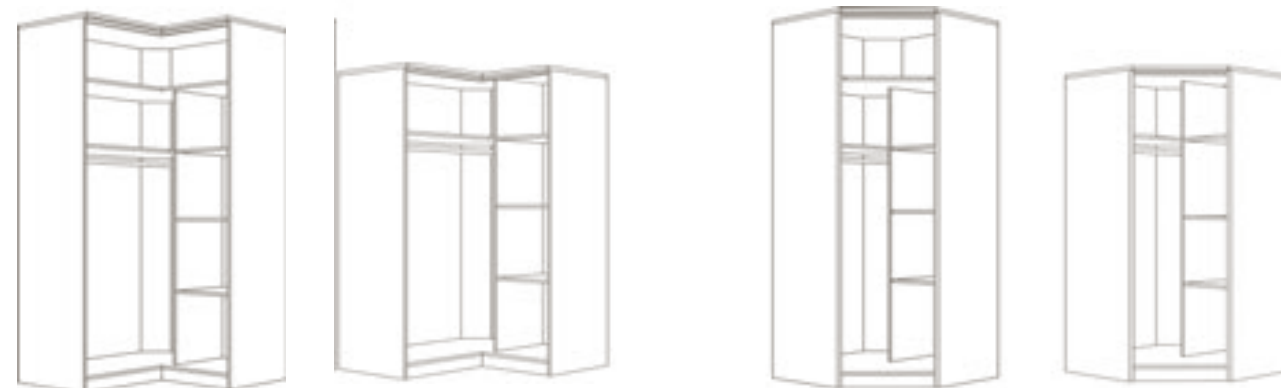

**Distribución interior armarios apilables 240**  
*Inner distribution for nestable wardrobes 240*



## Distribución interior armarios apilables 200

Inner distribution for nestable wardrobes 200

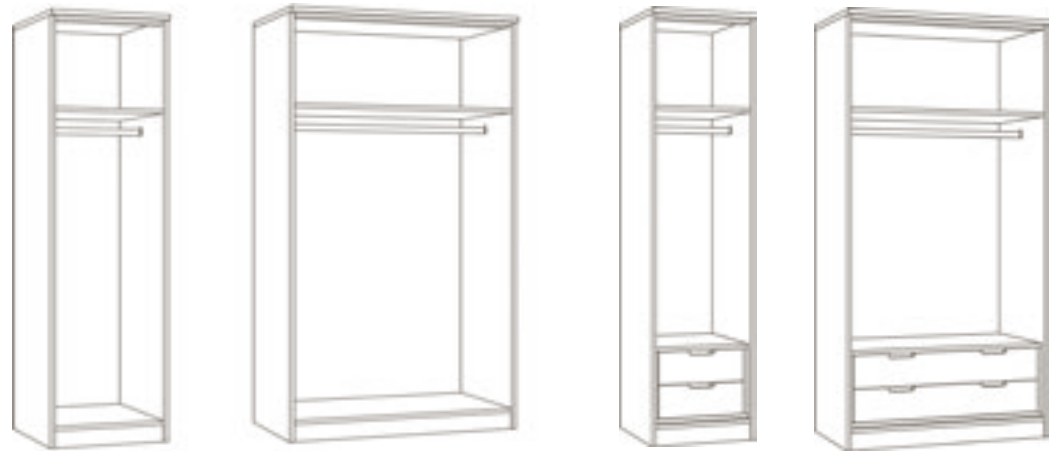

Cajonera opcional  
Optional chest of drawers

### POMOS KNOB

		
Pomo madera ø 45 mm	Pomo metálico plata envejecida ø 45 mm	Pomo metálico oro envejecido ø 45 mm

**\*NOTAS:**

Los pomos metálicos tendrán acabado oro envejecido y/o plata envejecida, indicándolo en el pedido.  
Los pomos de madera se pueden acabar en los colores de nuestra carta, indicándolo en el pedido.  
Todos los pedidos juveniles deberán incluir el modelo de tirador

**\*NOTES:**

Metal knobs are in aged gold and/or aged silver finishes, so please indicate which on your order.  
Wooden knobs can be finished in the colours shown on our colour card, so please indicate colour on your order.  
All orders for children's furniture must indicate knob model.

# COMPOSICIONES COMPOSITIONS

DORMITORIOS  
BEDROOMS



### COMP. 3J

	Ref.	UDS.	Descripción	Medidas	Puntos			
					A	B	C	A la Arena
	EL021	1	Costado izquierdo madera de 200	36,5 x 201 x 4,7	26	28	30	33
	EL023	1	Costado derecho madera de 200	36,5 x 201 x 4,7	26	28	30	33
	EL027	1	Trasera módulo 2 puertas de 200	95 x 192 x 0,6	14	16	17	18
	EL045	1	Techo módulo 2 puerta para altura 200 y 240	36 x 93 x 5	17	19	20	22
	EL049	4	Estante módulo 2 puerta (unidad A.15 B.16 C.18 Arena. 19)	30,3 x 93 x 1,9	60	64	72	76
	EL051	1	Base módulo 2 puerta	35 x 93 x 5	21	23	25	27
TOTAL PUNTOS					166	198	194	209

### COMP. 4J

Tosca

	Ref.	UDS.	Descripción	Medidas	Puntos			
					A	B	C	A la Arena
	EL002	1	Costado izquierdo madera de 88 para puertas	35 x 84,9 x 3,2	14	16	17	18
	EL004	1	Costado derecho madera de 88 para puertas	35 x 84,9 x 3,2	14	16	17	18
	EL006	1	Costado central madera de 88 para puertas	35 x 84,9 x 3,2	17	18	20	21
	EL007	2	Trasera módulo 2 puertas de 88 (unidad A.6 B.7 C.8 Arena. 9)	95 x 80 x 0,6	12	14	16	18
	EL043	2	Techo módulo 2 puerta para altura 88 y 160 (unidad A.15 B.17 C.18 Arena.20)	34,3 x 93 x 1,9	30	34	36	40
	EL049	2	Estante módulo 2 puerta (unidad A.15 B.16 C.18 Arena. 19)	30,3 x 93 x 1,9	30	34	36	40
	EL051	2	Base módulo 2 puerta (unidad A.21 B.23 C.25 Arena.27)	35 x 93 x 5	42	46	50	54
	EL054	4	Puerta baja cristal para altura de 88 y 160 (unidad A.11 B.12 C.13 Arena.14)	46,2 x 77,6 x 2,5	44	48	52	56
	EL059	1	Tapa 2 módulos de 2 puertas para altura de 88 y 160	198 x 38 x 3	33	37	40	43
	TOTAL PUNTOS					237	263	284

### COMP. 5J

Blanco Albo/Amarillo Soleado/Tosca/Verde Agua

	Ref.	UDS.	Descripción	Medidas	Puntos			
					A	B	C	A la Arena
	EL002	1	Costado izquierdo madera de 88 para puertas	35 x 84,9 x 3,2	14	16	17	18
	EL004	1	Costado derecho madera de 88 para puertas	35 x 84,9 x 3,2	14	16	17	18
	EL006	1	Costado central madera de 88 para puertas	35 x 84,9 x 3,2	17	18	20	21
	EL007	2	Trasera módulo 2 puertas de 88 (unidad A.6 B.7 C.8 Arena. 9)	95 x 80 x 0,6	12	14	16	18
	EL043	2	Techo módulo 2 puerta para altura 88 y 160 (unidad A.15 B.17 C.18 Arena.20)	34,3 x 93 x 1,9	30	34	36	40
	EL049	2	Estante módulo 2 puerta (unidad A.15 B.16 C.18 Arena. 19)	30,3 x 93 x 1,9	30	34	36	40
	EL051	2	Base módulo 2 puerta (unidad A.21 B.23 C.25 Arena.27)	35 x 93 x 5	42	46	50	54
	EL055	4	Puerta baja madera para altura de 88 y 240 (unidad A.18 B.20 C.22 Arena.23)	46,2 x 77,6 x 2,5	72	80	88	92
	EL059	1	Tapa 2 módulos de 2 puertas para altura de 88 y 160	198 x 38 x 3	33	37	40	43
	EL001	1	Costado izquierdo madera de 88	35 x 84,9 x 3,2	14	16	17	18
EL003	1	Costado derecho madera de 88	35 x 84,9 x 3,2	14	16	17	18	
EL005	1	Costado central madera de 88	35 x 84,9 x 3,2	17	18	20	21	
EL007	2	Trasera módulo 2 puertas de 88 (unidad A.6 B.7 C.8 Arena. 9)	95 x 80 x 0,6	12	14	16	18	
EL043	2	Techo módulo 2 puerta para altura 88 y 160 (unidad A.15 B.17 C.18 Arena.20)	34,3 x 93 x 1,9	30	34	36	40	
EL049	2	Estante módulo 2 puerta (unidad A.15 B.16 C.18 Arena. 19)	30,3 x 93 x 1,9	30	34	36	40	
EL051	2	Base módulo 2 puerta (unidad A.21 B.23 C.25 Arena.27)	35 x 93 x 5	42	46	50	54	
EL059	1	Tapa 2 módulos de 2 puertas para altura de 88 y 160	198 x 38 x 3	33	37	40	43	
TOTAL PUNTOS					458	510	552	597

### COMP. 10J

Blanco Dkp/Coral/Verde Agua

	Ref.	UDS.	Descripción	Medidas	Puntos			
					A	B	C	A la Arena
	EL021	1	Costado izquierdo madera de 200	36,5 x 201 x 4,7	26	28	30	33
	EL023	1	Costado derecho madera de 200	36,5 x 201 x 4,7	26	28	30	33
	EL025	1	Costado central de 200	36,5 x 201 x 4,7	32	35	38	40
	EL027	2	Trasera módulo 2 puertas de 200 (unidad A.14 B.16 C.17 Arena.18)	95 x 192 x 0,6	28	32	34	36
	EL045	2	Techo módulo 2 puerta para altura 200 y 240 (unidad A.17 B.19 C.20 Arena.22)	36 x 93 x 5	34	38	40	44
	EL049	8	Estante módulo 2 puerta (unidad A.15 B.16 C.18 Arena. 19)	30,3 x 93 x 1,9	120	128	144	152
	EL051	2	Base módulo 2 puerta (unidad A.21 B.23 C.25 Arena.27)	35 x 93 x 5	42	46	50	54
TOTAL PUNTOS					307	335	366	391

### COMP. 13J

Coral/Tabaco



Ref.	UDS.	Descripción	Medidas	Puntos			
				A	B	C	A la Arena
EL011	1	Costado izquierdo madera de 160	35 x 157 x 3,2	24	26	28	30
EL013	1	Costado derecho madera de 160	35 x 157 x 3,2	24	26	28	30
EL015	1	Costado central de 160	35 x 157 x 3,2	15	17	18	20
EL017	2	Trasera módulo 2 puertas de 160 (unidad A.12 B.13 C.14 Arena.15)	95 x 152,1 x 0,6	24	26	28	30
EL043	2	Techo módulo 2 puerta para altura 88 y 160 (unidad A.15 B.17 C.18 Arena.20)	34,3 x 93 x 1,9	30	34	36	40
EL049	6	Estante módulo 2 puerta (unidad A.15 B.16 C.18 Arena. 19)	30,3 x 93 x 1,9	90	96	108	114
EL051	2	Base módulo 2 puerta (unidad A.21 B.23 C.25 Arena.27)	35 x 93 x 5	42	46	50	54
EL059	1	Tapa 2 módulos de 2 puertas para altura de 88 y 160	198 x 38 x 3	33	37	40	43
EL011	1	Costado izquierdo madera de 160	35 x 157 x 3,2	24	26	28	30
EL013	1	Costado derecho madera de 160	35 x 157 x 3,2	24	26	28	30
EL017	1	Trasera módulo 2 puertas de 160	95 x 152,1 x 0,6	12	13	14	15
EL043	1	Techo módulo 2 puerta para altura 88 y 160	34,3 x 93 x 1,9	15	17	18	20
EL049	3	Estante módulo 2 puerta (unidad A.15 B.16 C.18 Arena. 19)	30,3 x 93 x 1,9	45	48	54	57
EL051	1	Base módulo 2 puerta	35 x 93 x 5	21	23	25	27
EL057	1	Tapa 1 módulo de 2 puertas para altura 88 y 160	105 x 39 x 3	19	20	22	24
TOTAL PUNTOS				441	482	526	563

### COMP. 14J

Blanco Albo/Azul Cielo



Ref.	UDS.	Descripción	Medidas	Puntos			
				A	B	C	A la Arena
EL012	1	Costado izquierdo madera de 160 para puertas	35 x 157 x 3,2	24	26	28	30
EL014	1	Costado derecho madera de 160 para puertas	35 x 157 x 3,2	24	26	28	30
EL016	1	Costado central de 160 para puertas	35 x 157 x 3,2	15	17	18	20
EL017	2	Trasera módulo 2 puertas de 160 (unidad A.12 B.13 C.14 Arena.15)	95 x 152,1 x 0,6	24	26	28	30
EL043	2	Techo módulo 2 puerta para altura 88 y 160 (unidad A.15 B.17 C.18 Arena.20)	34,3 x 93 x 1,9	30	34	36	40
EL049	6	Estante módulo 2 puerta (unidad A.15 B.16 C.18 Arena. 19)	30,3 x 93 x 1,9	90	96	108	114
EL051	2	Base módulo 2 puerta (unidad A.21 B.23 C.25 Arena.27)	35 x 93 x 5	42	46	50	54
EL052	4	Puerta alta cristal para altura de 160 y 240 (unidad A.15 B.17 C.18 Arena. 20)	46,2 x 149,7 x 2,5	60	68	72	80
EL059	1	Tapa 2 módulos de 2 puertas para altura de 88 y 160	198 x 38 x 3	33	37	40	43
TOTAL PUNTOS				342	376	408	440

### COMP. 29J

Blanco Decape/Turquesa



Ref.	UDS.	Descripción	Medidas	Puntos			
				A	B	C	A la Arena
EL012	1	Costado izquierdo madera de 160 para puertas	35 x 157 x 3,2	24	26	28	30
EL014	1	Costado derecho madera de 160 para puertas	35 x 157 x 3,2	24	26	28	30
EL016	1	Costado central de 160 para puertas	35 x 157 x 3,2	15	17	18	20
EL017	2	Trasera módulo 2 puertas de 160 A)12 B)13 C)14 Arena)15	95 x 152,1 x 0,6	24	26	28	30
EL043	2	Techo módulo 2 puerta para altura 88 y 160 A)4 B)5 C)6 Arena)7	34,3 x 93 x 1,9	8	10	12	14
EL049	6	Estante módulo 2 puerta A)15 B)16 C)18 Arena)19	30,3 x 93 x 1,9	45	48	54	57
EL051	2	Base módulo 2 puerta A)21 B)23 C)25 Arena)27	35 x 93 x 5	42	46	50	54
EL052	4	Puerta alta cristal para altura de 160 y 240 A)15 B)17 C)18 Arena)20	46,2 x 149,7 x 2,5	60	68	72	80
EL059	1	Tapa 2 módulos de 2 puertas para altura de 88 y 160	198 x 38 x 3	33	37	40	43
TOTAL PUNTOS				275	304	330	357

### COMP. 32J

Blanco Pluma/Natural/Turquesa



Ref.	UDS.	Descripción	Medidas	Puntos			
				A	B	C	A la Arena
EL011	1	Costado izquierdo madera de 160	35 x 157 x 3,2	24	26	28	30
EL013	1	Costado derecho madera de 160	35 x 157 x 3,2	24	26	28	30
EL015	1	Costado central de 160	35 x 157 x 3,2	15	17	18	20
EL017	2	Trasera módulo 2 puertas de 160 A)12 B)13 C)14 Arena)15	95 x 152,1 x 0,6	24	26	28	30
EL043	2	Techo módulo 2 puerta para altura 88 y 160 A)5 B)6 C)7 Arena)8	34,3 x 93 x 1,9	10	12	14	16
EL049	6	Estante módulo 2 puerta A)15 B)16 C)18 Arena)19	30,3 x 93 x 1,9	90	96	108	114
EL051	2	Base módulo 2 puerta A)21 B)23 C)25 Arena)27	35 x 93 x 5	42	46	50	54
EL059	1	Tapa 2 módulos de 2 puertas para altura de 88 y 160	198 x 38 x 3	33	37	40	43
TOTAL PUNTOS				262	286	314	337

composiciones

**COMP. 34A**

Blanco Decape/Coral/Turquesa



Ref.	UDS.	Descripción	Medidas	Puntos			
				A	B	C	A la Arena
3133	1	Estantería de puerta y hueco de 40 x 200 Izquierda	40 x 200 x 42	105	116	125	134
3102	1	Estantería sobre buck(completa altura 200)	50 x 155x 42	80	89	95	102
3100	1	Buck de 100 con 2 cajones	100 x 45 x 50	107	119	127	136
EC007	1	Estante de pared de 140	140 x 4 x 20	27	30	32	34
EC012	2	Cubo estante (cuadrado) A)21 B)23 C)25 Arena)27	40 x 40 x 25	42	46	50	54
BD01	1	Sofá nido Besora con arrastre	207 x 83 x 101	212	233	252	270
3006	1	Modulo arcón zapatero con reducción de fondo (sin tapa)	100 x 74 x -	123	136	145	155
3055	1	Encimera para reducción de arcon recta derecha de 260 (cortada a 240 cm)	240 x 50 x 3	64	71	76	81
7042	1	Pie de Ala Delia	6 x 74 x 45	23	25	27	29
TOTAL PUNTOS				783	865	929	995

**COMP. 36A**

Blanco Decape/Azul Mar



Ref.	UDS.	Descripción	Medidas	Puntos			
				A	B	C	A la Arena
7001	1	Sofá nido Danae con arrastre	206 x 67 x 100	241	268	286	306
3088	1	"Bajo 2 cajones y hueco de 40 (base encimera)"	40 x 74 x 47	67	74	80	86
7038	1	"Encimera rincón derecha 260 x 120 cm (cortada a 200 x 120 cm)"	200 x 120 x 3	99	110	118	126
3040	1	"Pie de ala para mesa estudio rincón"	42 x 74 x 42	23	25	27	29
3039	1	Pie de ala para mesa estudio	16 x 74 x 40	17	19	20	21
EC012	1	Cubo estante (cuadrado)	40 x 40 x 25	21	23	25	27
EC002	1	Estante de pared de 80	80 x 4 x 20	17	19	20	21
7071	1	Armario 1 puerta izquierda cristal-visillo y 2 cajones Camelia de 240	50 x 240 x 57	208	231	247	264
7066	1	Armario 2 puertas cristal-visillo y 2 cajones Camelia de 240	100 x 240 x 57	313	347	372	398
TOTAL PUNTOS				1006	1116	1195	1278

**COMP. 35A**

Blanco Decape/Tabaco



Ref.	UDS.	Descripción	Medidas	Puntos			
				A	B	C	A la Arena
DD03	1	Sofá nido Delia 3 cajones	201 x 72 x 100	281	310	334	358
3005	1	Módulo arcón zapatero (sin tapa)	100 x 74 x 47,5	112	123	132	141
3047	1	"Encimera con forma derecha de 260 cm (preparada para cortar a dos lados lados)"	260 x 70 x 3	64	71	76	81
3089	1	"Bajo 1 cajón y hueco de 40 (base encimera)"	40 x 74 x 47	61	68	72	77
EC014	1	Cubo estante doble	95 x 55 x 25	56	62	66	71
EC008	1	Estante de pared de 150	150 x 4 x 20	28	31	33	35
7108	1	Armario 2 puertas cristal-visillo y 1 cajón Delia de 240	100 x 240 x 57	299	332	355	380
TOTAL PUNTOS				901	997	1068	1143

**COMP. 37A**

Blanco Decape/Verde Agua/Amarillo Soleado



Ref.	UDS.	Descripción	Medidas	Puntos			
				A	B	C	A la Arena
7011	1	"Cama nido Delia con 3 cajones para arcón con apertura frontal"	203 x 55 x 100	254	282	302	323
3001	1	Módulo arcón con apertura frontal (sin tapa)	100 x 74 x 47,5	76	84	89	95
3049	1	"Encimera con forma derecha de 260 cm (preparada para cortar a un lado, cortada a 240)"	240 x 70 x 3	64	71	76	81
3039	1	Pie de ala para mesa estudio	16 x 74 x 40	17	19	20	21
EC013	2	Cubo estante (rectangular) A) 32 B)36 C)38 Arena)41	75 x 35 x 25	64	72	76	82
7085	1	"Armario rincón en ""L"" cristal-visillo (derecho) Camelia de 240"	120 x 240 x 106	419	465	498	533
7072	1	Armario 1 puerta derecha cristal-visillo y 1 cajón Camelia de 240	50 x 240 x 57	199	221	236	253
TOTAL PUNTOS				1093	1214	1297	1388

### COMP. 38A

Blanco Decape/Azul Cielo

	Ref.	UDS.	Descripción	Medidas	Puntos			
					A	B	C	A la Arena
	3023	1	"Cama nido Bétula para arcón con apertura frontal"	203 x 55 x 100	144	160	171	183
	3001	1	Módulo arcón con apertura frontal (sin tapa)	100 x 74 x 47,5	76	84	89	95
	3047	1	"Encimera con forma derecha de 260 cm (preparada para cortar a dos lados lados)"	260 x 70 x 3	64	71	76	81
	3036	1	"Cilindro regulable (apoyo encimera) sobre buck"	-	9	9	9	9
	3098	1	"Buck de 50 con 2 cajones (con ruedas)"	50 x 45 x 50	72	80	86	92
	EC013	1	Cubo estante (rectangular)	75 x 35 x 25	32	36	38	41
	7045	1	Armario 2 puertas cristal-visillo Camelia de 200	100 x 200 x 57	219	243	260	278
TOTAL PUNTOS					616	683	729	779

### COMP. 40A

Blanco Decape/Tabaco

	Ref.	UDS.	Descripción	Medidas	Puntos			
					A	B	C	A la Arena
	7089	1	Armario Camelia puertas correderas de 160	160 x 240 x 57	447	491	530	568
	EC008	1	Estante de pared de 150	150 x 4 x 20	28	31	33	35
	3100	1	Buck de 100 con 2 cajones	100 x 45 x 50	107	119	127	136
	3084	1	"Bajo diáfano de 40 con 1 estantemóvil (base encimera)"	40 x 74 x 45	39	43	46	49
	3047	1	"Encimera con forma derecha de 260 cm (preparada para cortar a dos lados lados)"	260 x 70 x 3	64	71	76	81
	3088	1	"Bajo 2 cajones y hueco de 40 (base encimera)"	40 x 74 x 47	67	74	80	86
	3003	1	Módulo arcón con apertura frontal y superior	100 x 77 x 47,5	101	111	119	127
3025	1	"Cama nido Bétula con 2 cajones para arcón con apertura frontal"	203 x 55 x 100	213	236	253	271	
TOTAL PUNTOS					1066	1176	1264	1353

### COMP. 39A

Natural/Verde Agua

	Ref.	UDS.	Descripción	Medidas	Puntos				
					A	B	C	A la Arena	
	3008	1	Cama nido Besora para arcón con apertura frontal	203 x 60 x 100	144	160	171	183	
	3001	1	Módulo arcón con apertura frontal (sin tapa)	100 x 74 x 47,5	76	84	89	95	
	3047	1	"Encimera con forma derecha de 260 cm (preparada para cortar a dos lados lados)"	260 x 70 x 3	64	71	76	81	
	3036	1	"Cilindro regulable (apoyo encimera) sobre buck"	-	9	9	9	9	
	3100	1	Buck de 100 con 2 cajones	100 x 45 x 50	107	119	127	136	
	3102	1	Estanteria sobre buck(completa altura 200)	50 x 155x 42	80	89	95	102	
	EC008	1	Estante de pared de 150	150 x 4 x 20	28	31	33	35	
	EC013	2	Cubo estante (rectangular) A) 32 B)36 C)38 Arena)41	75 x 35 x 25	64	72	76	82	
	TOTAL PUNTOS					572	635	676	724

### COMP. 41A

Blanco Decape/Tabaco

	Ref.	UDS.	Descripción	Medidas	Puntos			
					A	B	C	A la Arena
	3033	1	Panel lateral cama de 210	210 x 53 x 2,3	70	77	83	89
	7010	1	"Cama nido Delia con 2 cajones para arcón con apertura frontal"	203 x 55 x 100	213	236	253	271
	3001	1	Módulo arcón con apertura frontal (sin tapa)	100 x 74 x 47,5	76	84	89	95
	3047	1	"Encimera con forma derecha de 260 cm (preparada para cortar a dos lados lados)"	260 x 70 x 3	64	71	76	81
	3089	1	"Bajo 1 cajón y hueco de 40 (base encimera)"	40 x 74 x 47	61	68	72	77
	7077	1	Armario 1 puerta izquierda madera y 1 cajón Camelia de 240	50 x 240 x 57	199	221	236	253
	7083	1	"Armario rincón en chafflán puerta derecha madera Camelia de 240"	95 x 240 x 95	337	374	400	428
	7079	1	Terminal vestidor de 240 derecho con espejo	20 x 240 x 57	91	101	108	116
	EC002	1	Estante de pared de 80	80 x 4 x 20	17	19	20	21
	EC014	1	Cubo estante doble	95 x 55 x 25	56	62	66	71
	EC012	1	Cubo estante (cuadrado)	40 x 40 x 25	21	23	25	27
	TOTAL PUNTOS					1205	1336	1428



### COMP. 42A

Blanco Albo/Canela



Ref.	UDS.	Descripción	Medidas	Puntos			
				A	B	C	A la Arena
7051	1	"Armario diáfano con cajones y estantes de 200"	50 x 200 x 57	216	240	257	275
EC013	1	Cubo estante (rectangular)	75 x 35 x 25	32	36	38	41
EC005	1	Estante de pared de 120	120 x 4 x 20	22	24	26	28
VD012	1	Mesa de estudio Verona	110 x 84 x 55	96	106	113	121
3110	1	"Módulo cajones y hueco de 80 (sin tapa)"	80 x 108 x 42	154	171	183	196
3114	1	Tapa de ancho 80	80 x 2,3 x 45				
7001	1	Sofá nido Danae con arrastre	206 x 67 x 100	241	268	286	306
TOTAL PUNTOS				761	845	903	966

### COMP. 44A

Blanco Albo/Canela



Ref.	UDS.	Descripción	Medidas	Puntos			
				A	B	C	A la Arena
7013	1	"Cama block Delia con 2 camas y 2 cajones bajos con frente oculto"	203 x 80 x 100	359	398	426	456
3005	1	Módulo arcón zapatero (sin tapa)	100 x 74 x 47,5	112	123	132	141
3049	1	"Encimera con forma derecha de 260 cm (preparada para cortar aun lado-cortada a 240)"	240 x 70 x 3	64	71	76	81
3039	1	Pie de ala para mesa estudio	16 x 74 x 40	17	19	20	21
7130	1	"Armario puertas correderas Delia de 160"	160 x 240 x 57	449	494	534	571
EC007	1	Estante de pared de 140	140 x 4 x 20	27	30	32	34
EC014	1	Cubo estante doble	95 x 55 x 25	56	62	66	71
TOTAL PUNTOS				1084	1197	1286	1376

### COMP. 43A

Blanco Albo/Canela



Ref.	UDS.	Descripción	Medidas	Puntos			
				A	B	C	A la Arena
DD01	1	Sofá nido Delia con arrastre	201 x 72 x 100	203	224	241	258
7042	1	Pie de ala Delia	6 x 74 x 45	23	25	27	29
3040	1	Pie de ala para mesa estudio rincón	42 x 74 x 42	23	25	27	29
7039	1	"Encimera rincón izquierda 260 x 120 cm (preparada para cortar-cortada 200 x 120)"	200 x 120 x 3	99	110	118	126
3088	1	"Bajo 2 cajones y hueco de 40 (base encimera)"	40 x 74 x 47	67	74	80	86
7066	1	Armario 2 puertas cristal-visillo y 2 cajones Camelia de 240	100 x 240 x 57	313	347	372	398
3080	2	"Módulo estante de 163 diáfano de fondo 25 A)85 B)94 C)101 C)108"	100 x 163 x 25	170	188	202	216
TOTAL PUNTOS				898	993	1067	1142

### COMP. 45A

Blanco Albo/Turquesa



Ref.	UDS.	Descripción	Medidas	Puntos			
				A	B	C	A la Arena
7066	1	Armario 2 puertas cristal-visillo y 2 cajones Camelia de 240	100 x 240 x 57	313	347	372	398
3122	1	Altillo 2 puertas elevables de 210	210 x 61 x 42	193	214	229	245
3129	1	"Alto estante de 210, para 200 y 240 (fondo 45)"	210 x 25 x 25	55	61	65	70
3030	1	"Cama block Bétula con 2 camas y 2 cajones altos"	203 x 80 x 100	285	316	338	362
3079	1	"Módulo alto de 163 diáfano de fondo 40"	50 x 163 x 40	83	92	99	106
3005	1	Módulo arcón zapatero (sin tapa)	100 x 74 x 47,5	112	123	132	141
3047	1	"Encimera con forma derecha de 260 cm (preparada para cortar a dos lados)"	260 x 70 x 3	64	71	76	81
3088	1	"Bajo 2 cajones y hueco de 40 (base encimera)"	40 x 74 x 47	67	74	80	86
TOTAL PUNTOS				1172	1298	1391	1488





